

Dell™ Interactive Projector S520

User's Guide



Notes, Cautions, and Warnings



NOTE: A NOTE indicates important information that helps you make better use of your projector



CAUTION: A CAUTION indicates potential damage to hardware or loss of data if instructions are not followed.



WARNING: A WARNING indicates a potential for property damage, personal injury, or death.

Information in this document is subject to change without notice.

© 2013 Dell Inc. All rights reserved.

Reproduction of these materials in any manner whatsoever without the written permission of Dell Inc. is strictly forbidden.

Trademarks used in this text: Dell and the DELL logo are trademarks of Dell Inc.; DLP and DLP logo are trademarks of TEXAS INSTRUMENTS INCORPORATED; Microsoft and Windows are either trademarks or registered trademarks of Microsoft Corporation in the United States and/or other countries.

Other trademarks and trade names may be used in this document to refer to either the entities claiming the marks and names or their products. Dell Inc. disclaims any proprietary interest in trademarks and trade names other than its own.

Model: Dell Interactive Projector S520

September 2013 Rev. A00

Contents

1	Your Dell Projector	5
2	Connecting Your Projector	9
	Connecting to a Computer	11
	Connecting a DVD Player	17
	Connecting to Local Area Network.	21
3	Using Your Projector	25
	Turning Your Projector On.	25
	Turning Your Projector Off	25
	Adjusting the Projector Focus	26
	Cleaning the Projector's Mirror	26
	Adjusting Projection Image Size	27
	Using the Remote Control.	29
	Installing the Remote Control Batteries	32
	Operating Range with Remote Control	33
	Using the On-Screen Display.	34
	Multimedia Introduction	54
	How to set-up File Type for Multimedia with USB	56
	How to set-up File Type for Multimedia with Internal Memory	58
	Office Viewer for the USB and Internal Memory	60
	Multimedia SETUP for USB and Internal Memory.	61
	Intel® Wireless Display (WiDi) Installation.	62
	Enable Intel® WiDi on the Projector	64
	Wireless Display or LAN Display Installation	67
	Enable Wireless or LAN on the Projector	68
	Audio Projection Installation	80
	Using the Audio Projection	86
	Managing the Projector From Web Management	88
	Make Application Token	106
4	Troubleshooting Your Projector	107
	Guiding Signals	112

	Laser Curtain LED Guiding Signals	113
	Changing the Lamp	114
5	Specifications	116
6	Contacting Dell	122
	Contacting eInstruction	123
	Contacting Crestron	124
7	Appendix: Glossary	125

1

Your Dell Projector

Your projector comes with all the items shown below. Ensure that you have all the items, and contact Dell if anything is missing.

Package Contents

Power cable

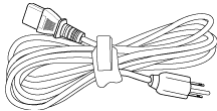

5 m VGA cable (VGA to VGA)

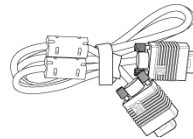

Remote control



AAA Batteries (2)



CD User's Guide and Documentation Laser curtain kit

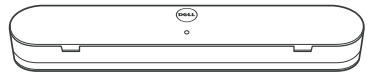
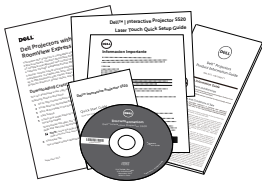

5 m Mini USB cable (USB-A to Mini USB-B)

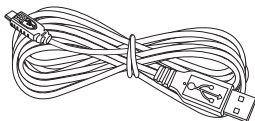

2 m DC to DC cable (for Laser curtain)

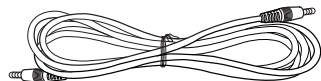

Package Contents

Passive Pen (2 pcs)

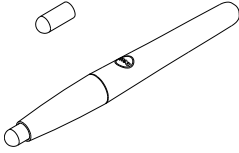

Interwrite Workspace CD



Alignment bar (3 pcs)



Screw for laser curtain



Wall mount kit

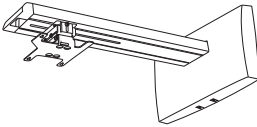

About Your Projector

Top View

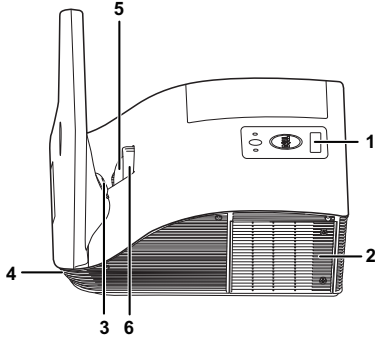

Bottom View

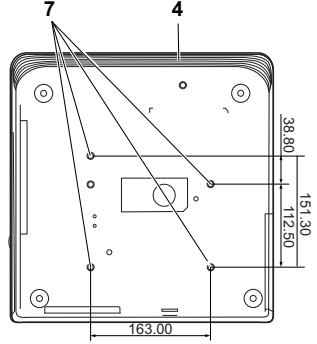

1	IR receivers
2	Lamp cover
3	Camera
4	10 W speaker
5	Lens
6	Focus ring
7	Mounting holes for wall mount: Screw hole M4 x 8 mm depth. Recommended torque <10 kgf-cm

CAUTION: Safety Instructions

- 1 Do not use the projector near appliances that generate a lot of heat.
- 2 Do not use the projector in areas where there is an excessive amount of dust. The dust may cause the system to fail and the projector will automatically shutdown.
- 3 Ensure that the projector is mounted in a well-ventilated area.
- 4 Do not block the ventilation slots and openings on the projector.
- 5 Ensure the projector operates between ambient temperatures (5 °C to 35 °C).
- 6 Do not try to touch the ventilation outlet as it can become very hot after the projector has been turned on or immediately after it is turned off.
- 7 Do not look into the lens while the projector is on as it may cause injury to your eyes.
- 8 Do not place any objects near or in front of the projector or cover its lens while the projector is on as the heat may cause the object to melt or burn.
- 9 Do not use the wireless projector near cardiac pacemakers.
- 10 Do not use the wireless projector near medical equipment.
- 11 Do not use the wireless projector near microwave ovens.

NOTE:

- Do not attempt to wall mount the projector by yourself. It should be installed by a qualified technician.
- Recommended Projector Wall Mount Kit (P/N: 7XY53). For more information, see the Dell Support website at **dell.com/support**.
- For more information, see the *Safety Information* that shipped with your projector.
- The S520 projector can only be used indoors.

2

Connecting Your Projector

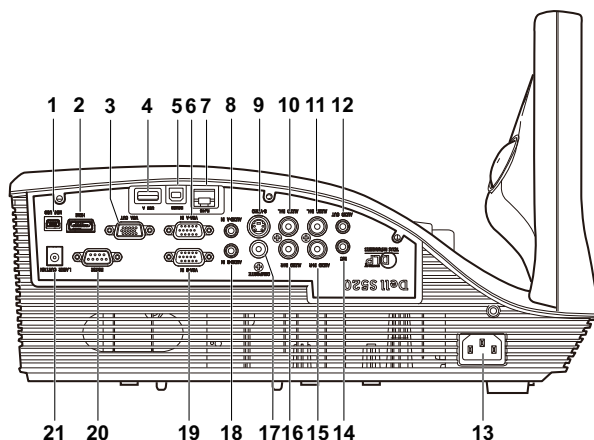

1	Mini USB (Mini Type B) connector for remote mouse, firmware upgrade, and laser curtain touch HID	12	Audio output connector
2	HDMI connector	13	Power cord connector
3	VGA output (monitor loop through) connector	14	Microphone connector
4	USB Type A connector for USB Viewer	15	Audio-B right-channel input connector
5	USB Type B connector (DoUSB) for USB Display	16	Audio-A right-channel input connector
6	VGA-A input (D-sub) connector	17	Composite Video connector
7	RJ-45 connector	18	Audio-B input connector
8	Audio-A input connector	19	VGA-B input (D-sub) connector
9	S-Video Connector	20	RS232 connector

10	Audio-A left-channel input connector	21	Laser curtain connector
----	--------------------------------------	----	-------------------------

11	Audio-B left-channel input connector		
----	--------------------------------------	--	--

 **CAUTION:** Before you begin any of the procedures in this section, follow the Safety Instructions as described on page 8.

Connecting to a Computer

Connecting a Computer Using a VGA Cable

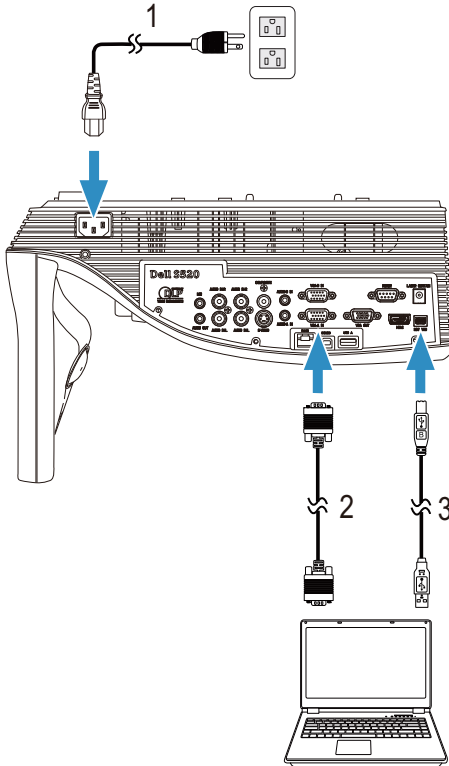

- 1 Power cord
- 2 VGA to VGA cable
- 3 USB-A to Mini USB-B cable



NOTE: The Mini USB cable must be connected if you want to use the Page Up and Page Down features on the remote control.

Monitor Loop-Through Connection Using VGA Cables

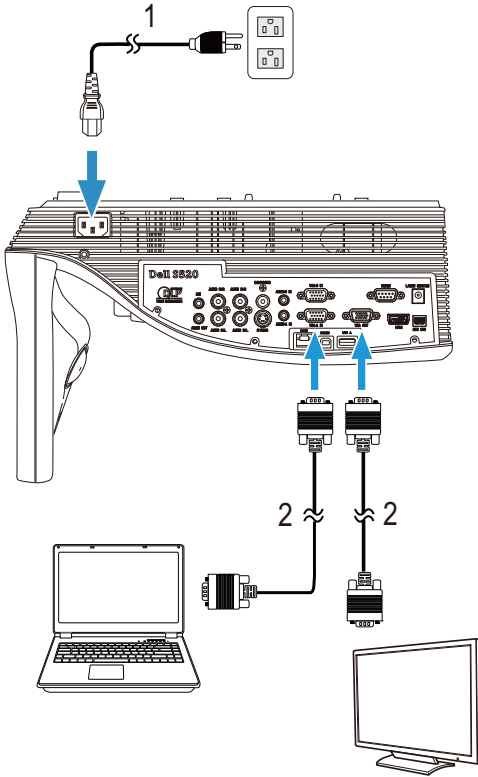

-
- | | |
|---|------------------|
| 1 | Power cord |
| 2 | VGA to VGA cable |
-

 **NOTE:** Only one VGA cable is shipped with your projector. An additional VGA cable can be purchased on the Dell website at www.dell.com.

Connecting a Computer Using a RS232 cable

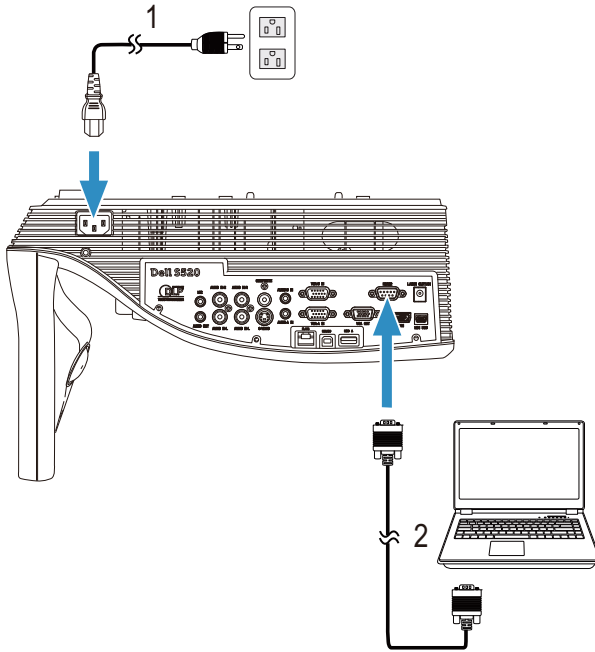

-
- 1 Power cord
 - 2 RS232 (9-pin D-sub female to female pin2-3 swap) cable
-

 **NOTE:** The RS232 (9-pin D-sub female to female pin2-3 swap) cable is not shipped with your projector. Consult a professional installer for the cable and RS232 remote control software.

Connecting a Computer Using a USB Cable

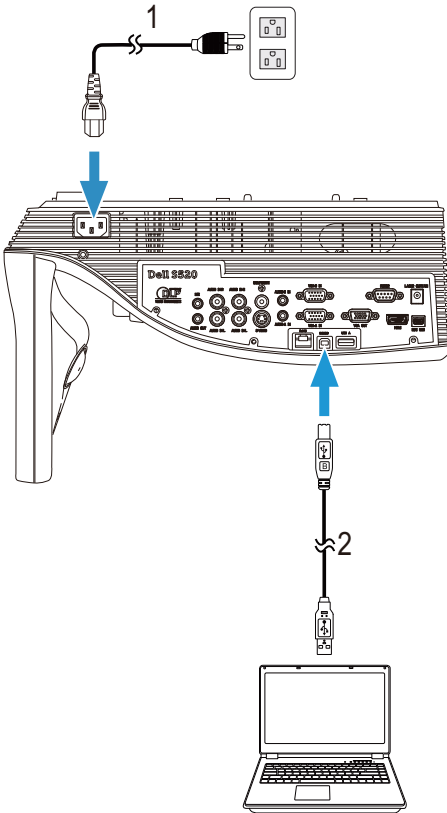



-
- | | |
|---|----------------------|
| 1 | Power cord |
| 2 | USB-A to USB-B cable |
-

 **NOTE:** Plug and Play. Only one USB cable is shipped with your projector. An additional USB cable can be purchased on the Dell website at www.dell.com.

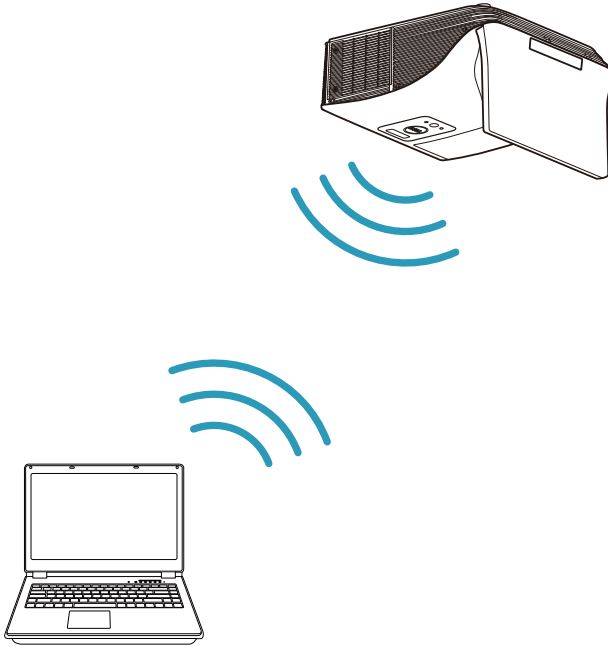
Connecting a Computer Using Wireless or Intel® WiDi



 **NOTE:** Your computer should be equipped with a wireless connector and properly configured to detect another wireless connection. Refer to your computer's documentation on how to configure a wireless connection.

 **NOTE:** To connect a computer via Intel® WiDi, your computer must be Intel® WiDi compatible.

Connecting to Smartphone or Tablet Using Wireless

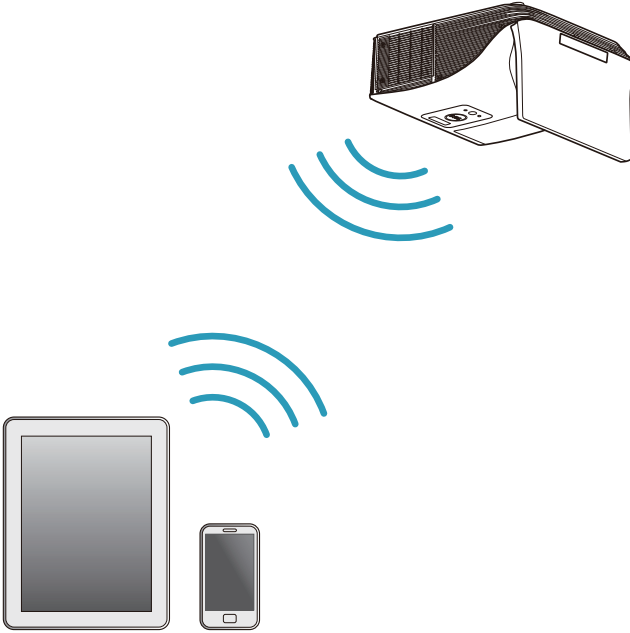

NOTE: Dell S520 supports MobiShow and WiFi-Doc functions. They are applications which transmit supported content from your Android or iOS devices wirelessly. After installing and launching the application on your mobile device, enable Wi-Fi on your mobile device and connect to the projector network, Dell S520. For more Information, please visit go to Dell Support site at dell.com/support. Files supported are:

Mobi Show	Photos	jpeg / jpg
	MS Powerpoint	PtG2 (converted from ppt)*
WiFi-Doc	Photos	jpeg / jpg
	MS Powerpoint / Word / Excel / Text / PDF	ppt / pptx / doc / docx / xls / xlsx / txt / pdf

* Please install the PtG2 Converter into your PC for file conversion of ppt into PtG2 format. PtG2 Converter can be downloaded from dell.com/support.

Connecting a DVD Player

Connecting a DVD Player Using an S-Video Cable

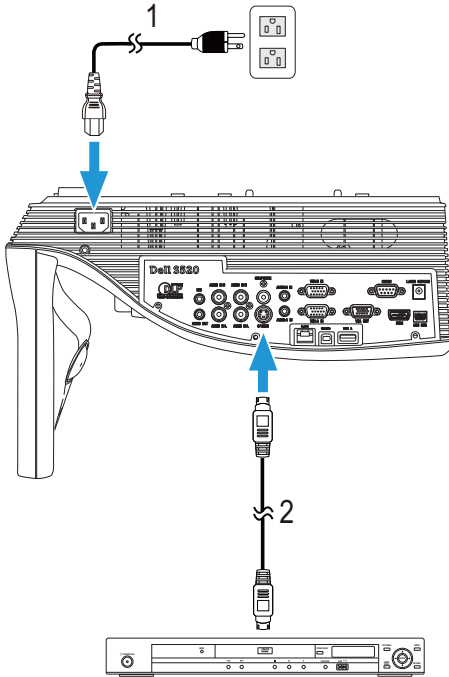

1 Power cord

2 S-Video cable



NOTE: The S-Video cable is not shipped with your projector. You can purchase the S-Video extension (50 ft/100 ft) cable on the Dell website at www.dell.com.

Connecting a DVD Player Using a Composite Video Cable

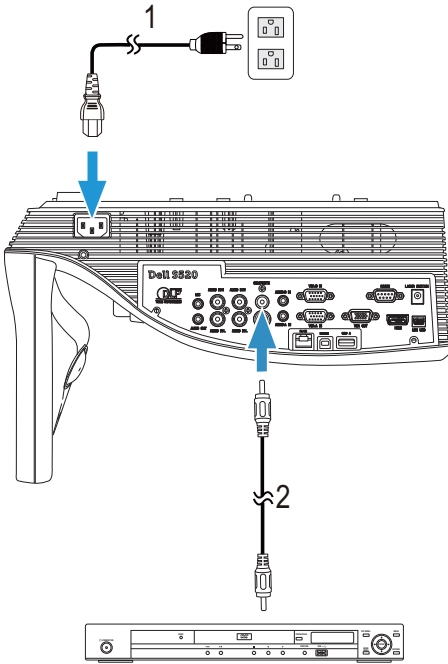

-
- 1 Power cord
 - 2 Composite Video cable
-



NOTE: The Composite Video cable is not shipped with your projector. You can purchase the Composite Video Extension (50 ft/100 ft) cable on the Dell website at www.dell.com.

Connecting a DVD Player Using a Component Video Cable

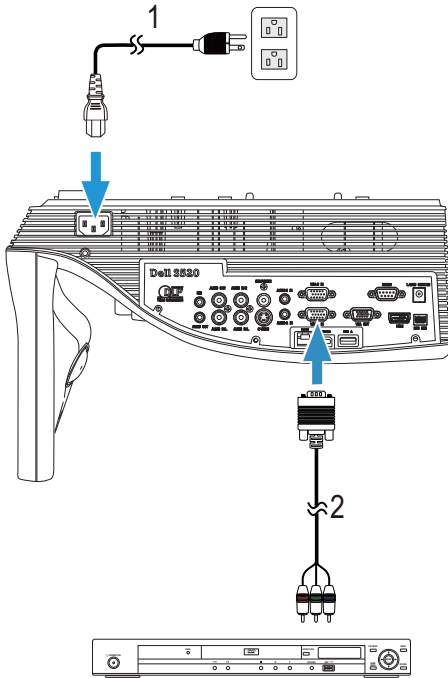

-
- 1 Power cord
 - 2 VGA to Component Video cable
-



NOTE: The VGA to Component Video cable is not shipped with your projector. You can purchase the VGA to Component Video Extension (50 ft/100 ft) cable on the Dell website at www.dell.com.

Connecting a DVD Player Using a HDMI Cable

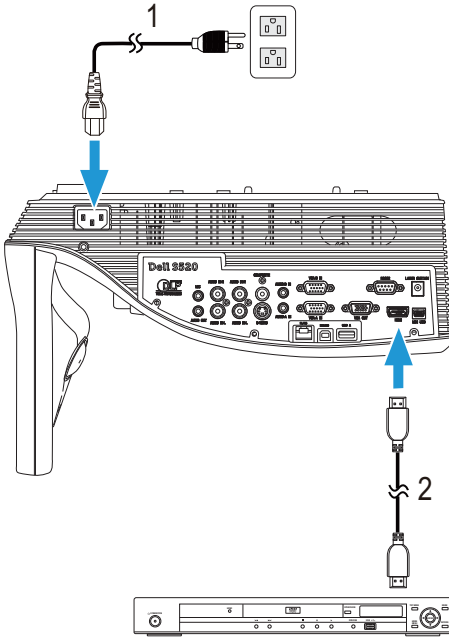

-
- 1 Power cord
 - 2 HDMI cable
-

 **NOTE:** The HDMI cable is not shipped with your projector. You can purchase the HDMI cable on the Dell website at www.dell.com.

Connecting to Local Area Network

To project an image and control the projector that is connected to a network through a RJ45 cable.

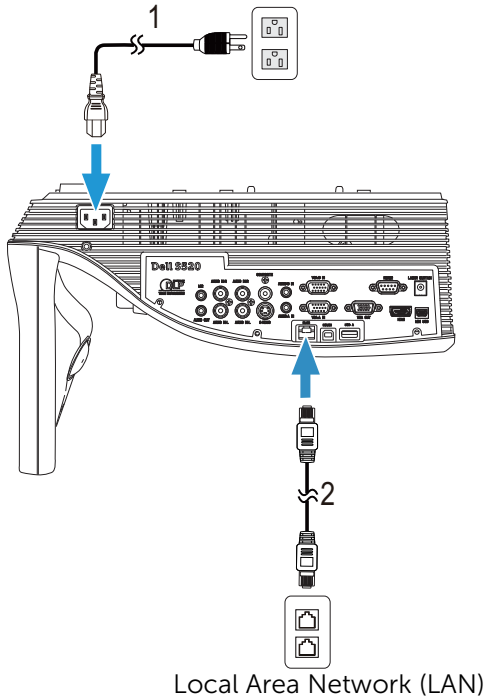

1 Power cord

2 RJ45 cable



NOTE: The RJ45 cable is not shipped with your projector. You can purchase the RJ45 cable on the Dell website at www.dell.com.

Connection With Commercial RS232 Control Box

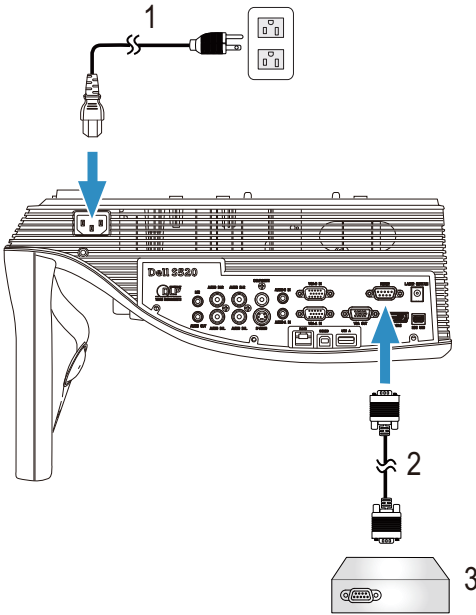

- | | |
|---|--|
| 1 | Power cord |
| 2 | RS232 (9-pin D-sub female to female pin2-3 swap) cable |
| 3 | Commercial RS232 control box |

 **NOTE:** The RS232 (9-pin D-sub female to female pin2-3 swap) cable is not shipped with your projector. Consult a professional technician to obtain the cable.

Connecting With Your Laser Curtain for Interactivity

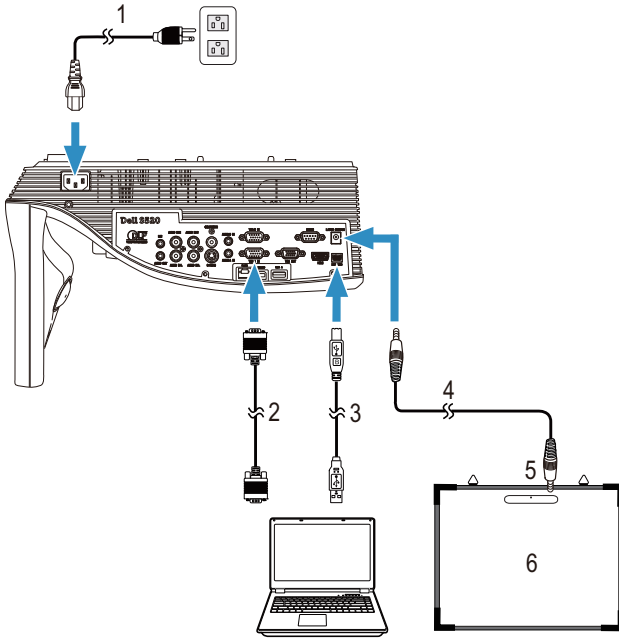

- | | |
|---|---------------------------|
| 1 | Power cord |
| 2 | VGA to VGA cable |
| 3 | USB-A to Mini USB-B cable |
| 4 | DC to DC cable |
| 5 | Laser curtain |
| 6 | Whiteboard |

NOTE:

- 1 The Laser Curtain is shipped with your whiteboard.
- 2 The Laser Curtain should be installed 2 cm higher than the upper edge of the projection screen.
- 3 The flatness of the whiteboard should be 2 mm or less.
- 4 Either of the VGA and HDMI cables can be connected to the computer and projector.

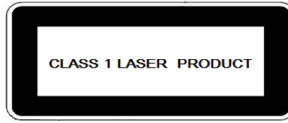

Complies with 21 CFR 1040.10 and 1040.11 except for deviations pursuant to Laser Notice No. 50, dated June 24, 2007.
IEC 60825-1:2007

 **CAUTION:**

Laser Precautions

- This product is a Class 1 laser device that conforms with IEC 60825-1:2007.
- This product has built-in laser module. Disassembly or modification is very dangerous and should never be attempted.
- Any operation or adjustment not specifically instructed by the user's guide creates the risk of hazardous laser radiation exposure.

3

Using Your Projector

Turning Your Projector On



NOTE: Turn on the projector before you turn on the source (computer, DVD player, etc.). The **Power** button light blinks white until pressed.

- 1 Connect the power cord and appropriate signal cables to the projector. For information about connecting the projector, see "Connecting Your Projector" on page 9.
- 2 Press the **Power** button (see "Using the Remote Control" on page 29 to locate the **Power** button).
- 3 Turn on your source (computer, DVD player, etc.)
- 4 Connect your source to the projector using the appropriate cable. See "Connecting Your Projector" on page 9 for instructions to connect your source to the projector.
- 5 By default, the input source of the projector is set to VGA-A. Change the input source of the projector if necessary.
- 6 If you have multiple sources connected to the projector, press the **Source** button on the remote control to select the desired source. See "Using the Remote Control" on page 29 to locate the **Source** button.

Turning Your Projector Off



CAUTION: Unplug the projector after properly shutting down as explained in the following procedure.

- 1 Press the **Power** button. Follow the instruction displayed on screen to properly turn off the projector.



NOTE: The "**Press Power Button to Turn off Projector**" message will appear on the screen. The message disappears after 5 seconds or you can press the **Menu** button to clear it.

- 2 Press the **Power** button again. The cooling fans continue to operate for 120 seconds.
- 3 To power off the projector quickly, press the **Power** button and hold for 1 second while the projector's cooling fans are still running.



NOTE: Before you turn on the projector again, wait for 60 seconds to allow the internal temperature to stabilize.

4 Disconnect the power cord from the electrical outlet and the projector.

Adjusting the Projector Focus

1 Rotate the focus ring until the image is clear. The projector focuses at distances ranging between 1.96 ft to 2.4 ft (0.597 m to 0.731 m).

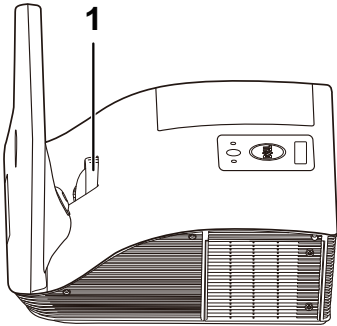

1	Focus ring
---	------------

Cleaning the Projector's Mirror

- 1 Turn off the projector power and disconnect the power cord.
- 2 Let the projector cool for at least 30 minutes.
- 3 Use air blower bulb to blow off dust on the mirror or gently wipe the mirror by using a microfiber cleaning cloth. Do not scrub the surface of the mirror. It may scratch the mirror.



CAUTION: Do not spray cleaners or solvents directly on the projector.



WARNING: Cleaning a wall-mounted projector can result in a fall or injury. You can remove the projector from the wall-mounting bracket to clean the projector's mirror.

Adjusting Projection Image Size

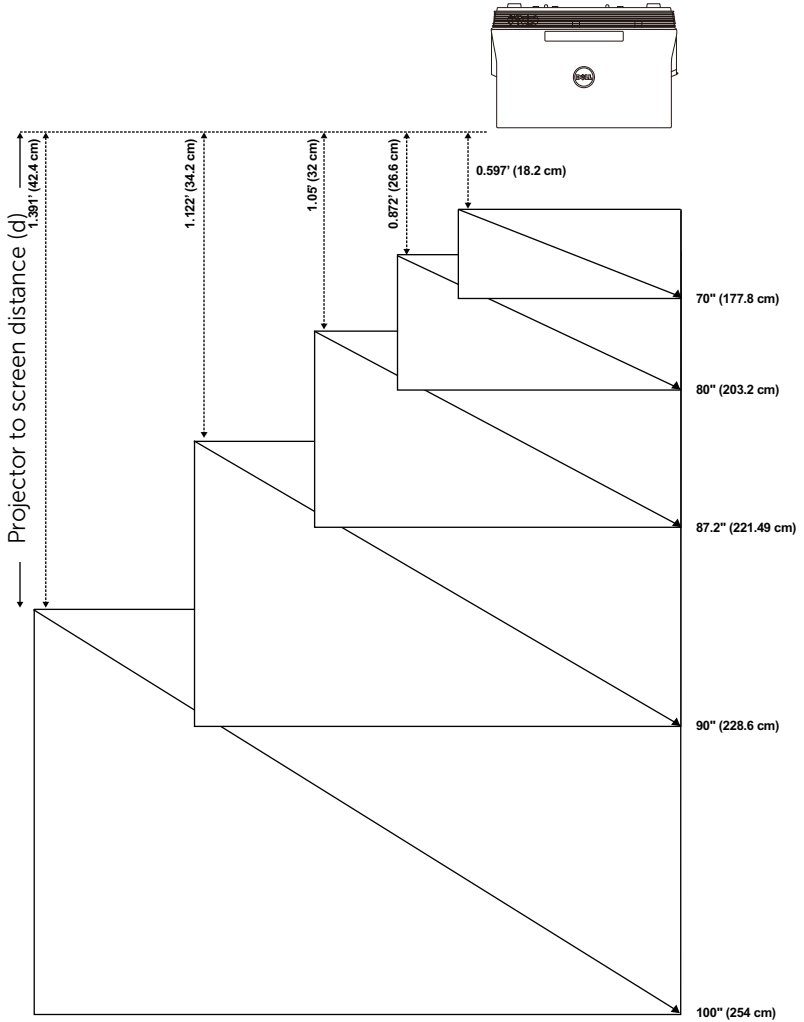

Projection Distance (cm) [A]	Projection Distance (cm) [B]	Image size			Projector base to top of image (cm) [D]	Projector base to bottom of image (cm) [E]
		Diagonal (inch/cm) [C]	Width (cm)	Height (cm) [H]		
51.7	18.2	70"/177.8 cm	148	92	120	28
60.1	26.6	80"/203.2 cm	172	107	139	32
65.5	32	87.2"/221.4 cm	187	117	151	34
67.7	34.2	90"/228.6 cm	193	121	156	35
75.9	42.4	100"/254 cm	217	136	175	39

* This graph is for user reference only.
* Offset Ratio: 125±5%

NOTE: The distance from mirror to the rear of projector: 33.5 cm

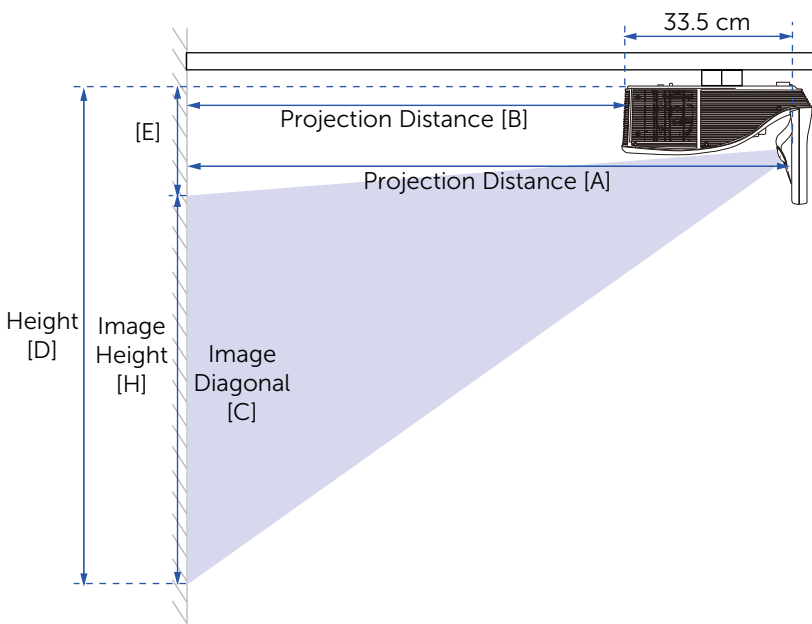

Using the Remote Control

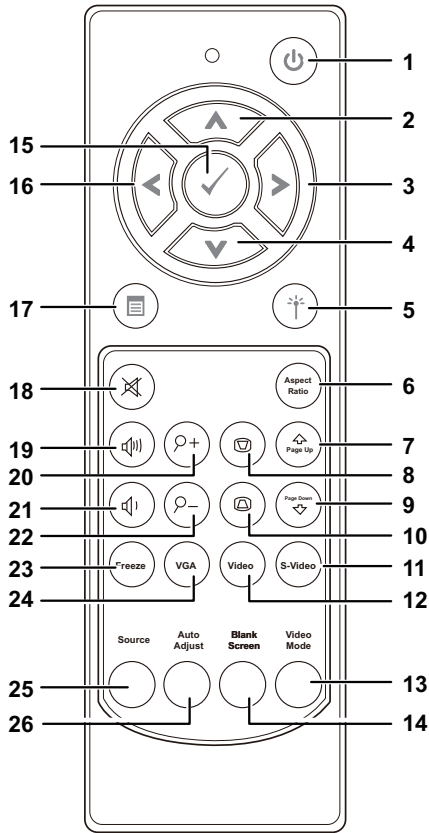

1 Power 

Turns the projector on or off. For more information, see "Turning Your Projector On" on page 25 and "Turning Your Projector Off" on page 25.

2 Up 













Press to navigate through the On-Screen Display (OSD) Menu items.









3 Right 

Press to navigate through the On-Screen Display (OSD) Menu items.

4 Down 

Press to navigate through the On-Screen Display (OSD) Menu items.

5	Laser 	Point the remote control at the screen, press and hold the laser button to activate the laser light.
		 CAUTION: Do not look at the laser point when it is active. Avoid directing the laser light on your eyes.
6	Aspect Ratio 	Press to change the aspect ratio of a displayed image.
7	Page up 	Press to move to the previous page.
		 NOTE: The Mini USB cable must be connected if you want to use the Page Up feature.
8	Keystone adjustment + 	Press to adjust image distortion caused by tilting the projector (-20/+20 degrees).
9	Page down 	Press to move to the next page.
		 NOTE: The Mini USB cable must be connected if you want to use the Page Down feature.
10	Keystone adjustment - 	Press to adjust image distortion caused by tilting the projector (-20/+20 degrees).
11	S-Video 	Press to choose S-Video source.
12	Video 	Press to choose Composite Video source.
13	Video mode	<p>The projector has preset configurations that are optimized for displaying data (presentation slides) or video (movies, games, etc.).</p> <p>Press the Video Mode button to toggle between Presentation mode, Bright mode, Movie mode, sRGB, or Custom mode.</p> <p>Pressing the Video Mode button once will show the current display mode. Pressing the Video Mode button again will switch between modes.</p>
14	Blank screen	Press to hide/unhide the image.
15	Enter 	Press to confirm the selection.

16	Left 	Press to navigate through the On-Screen Display (OSD) Menu items.
17	Menu 	Press to activate the OSD.
18	Mute 	Press to mute or un-mute the projector speaker.
19	Volume up 	Press to increase the volume.
20	Zoom + 	Press to increase the image.
21	Volume down 	Press to decrease the volume.
22	Zoom - 	Press to decrease the image.
23	Freeze 	Press to pause the screen image, then press "Freeze" again to unfreeze the image.
24	VGA 	Press to choose VGA source.
25	Source	Press to switch between VGA-A, VGA-B, Composite, S-Video, HDMI, Wireless Display, USB Display, USB Viewer, Intel® WiDi, and Internal Memory source.
26	Auto Adjust	Press to synchronize the projector with the input source. Auto adjust does not operate if the OSD is displayed.

Installing the Remote Control Batteries



NOTE: Remove the batteries from the remote control when not in use.

1 Press the tab to lift the battery compartment cover.

1

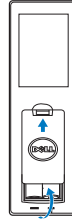

2 Check the polarity (+/-) marking on the batteries.

2

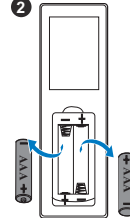

3 Insert the batteries and align their polarity correctly according to the marking in the battery compartment.

3

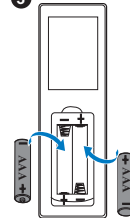

4 Slip the battery cover back.

4

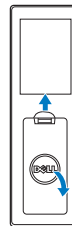





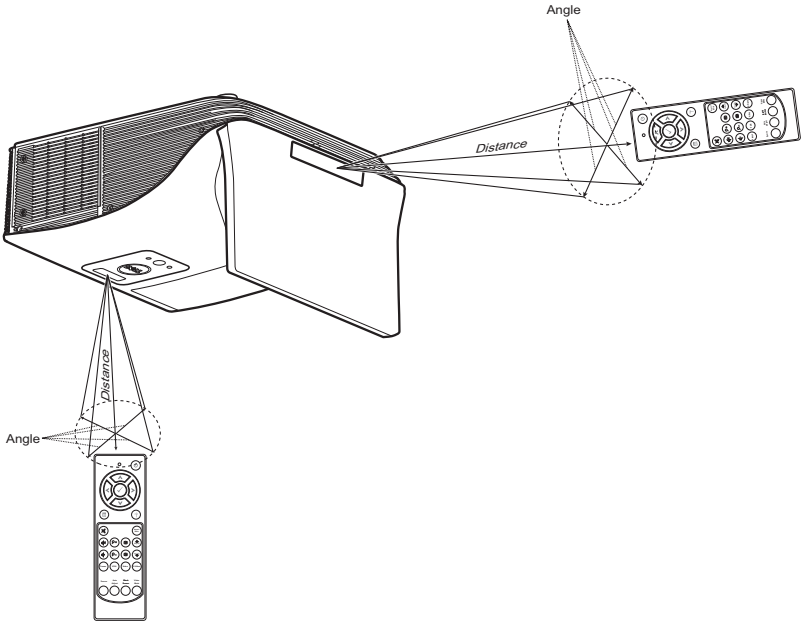



Operating Range with Remote Control

Operating range	
Angle	$\pm 40^\circ$
Distance	7 m/22.97 feet



NOTE: Actual operating range may slightly differ from the diagram. Weak batteries will also prevent the remote control from properly operating the projector.

Using the On-Screen Display

- The projector has a multi-language On-Screen Display (OSD) Menu that can be displayed with or without an input source.
- Press the Menu button on the remote control to enter the Main Menu.
- To navigate through the tabs in the Main Menu, press the  or  buttons on the remote control.
- To select a submenu, press the  or  button on the remote control.
- To select an option, press the  or  buttons on the remote control. When an item is selected, the color changes to dark blue.
- Use the  or  buttons on the remote control to adjust the settings.
- To go back to the Main Menu, press the  button on the remote control.
- To exit the OSD, press the Menu button directly on the remote control.

INPUT SOURCE

The Input Source menu allows you to select your projector's input source.

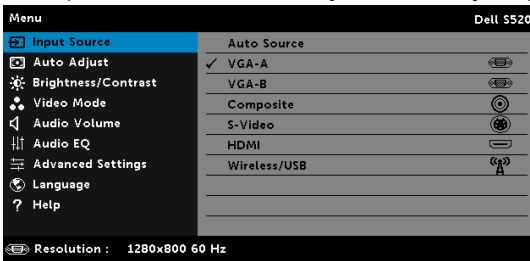



VGA-A—Press  to detect a VGA-A signal.

VGA-B—Press  to detect a VGA-B signal.

COMPOSITE—Press  to detect a Composite Video signal.

S-VIDEO—Press  to detect a S-Video signal.

HDMI—Press  to detect a HDMI signal.

WIRELESS/USB—Press  to activate the Input Source WIRELESS/USB menu.



NOTE: The WIRELESS/USB can be used after the "Wireless and LAN" option is turned on.

INPUT SOURCE WIRELESS/USB

The Input Source Wireless/USB menu allows you to activate the Wireless Display, USB Display, USB Viewer, Intel® WIDI and Internal Memory.

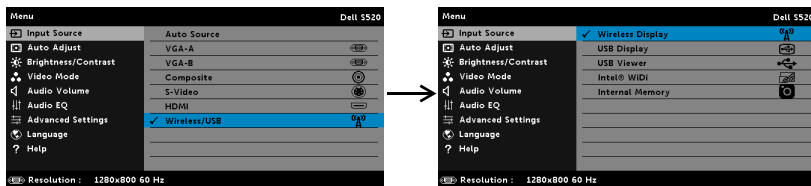

WIRELESS DISPLAY—Press to access the projector's Wireless Guide screen. See "Wireless Guide screen" on page 69.

USB DISPLAY—Allows you to display the computer/laptop screen to your projector via the USB cable.



NOTE: If the DoUSB can not display, please see "Troubleshooting Your Projector" on page 107.

USB VIEWER—Allows you to playback the photo, music, video, and MS word, excel, powerpoint, and PDF files from your USB flash disk.

INTEL® WIDI—Press to access the projector's Intel® WiDi Guide screen.

INTERNAL MEMORY—Allows you to playback the photo, music, video, and MS word, excel, powerpoint, and PDF files from internal memory of the projector.



NOTE:

STORAGE MODE—You may also connect USB cable in Internal Memory source to execute copy, delete, move and more instructions from your computer to projector internal memory and SD card.

When you connect the projector and computer via USB cable, a USB Connected message will pop up and allow you to select DoUSB or Storage Mode.

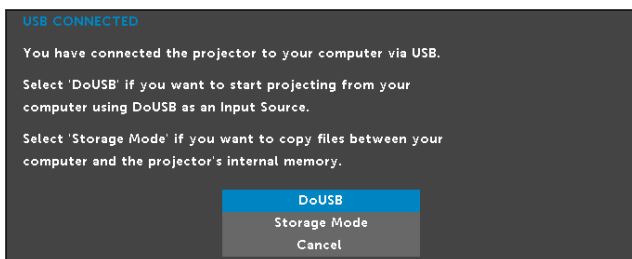

AUTO ADJUST

Auto Adjust automatically adjusts the projector's Horizontal, Vertical, Frequency, and Tracking in PC mode.

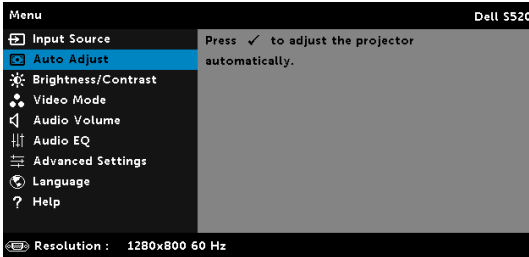

BRIGHTNESS/CONTRAST

The Brightness/Contrast menu allows you adjust the brightness/contrast settings of your projector.

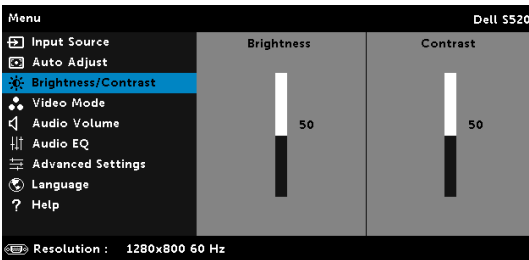

BRIGHTNESS—Use and to adjust the brightness of the image.

CONTRAST—Use and to adjust the display contrast.



NOTE: If you adjust the settings for **Brightness** and **Contrast** the projector automatically switches to Custom mode.

VIDEO MODE

The Video Mode menu allows you to optimize the display image: **Presentation**, **Bright**, **Movie**, **sRGB** (provides more accurate color representation), and **Custom** (set your preferred settings).

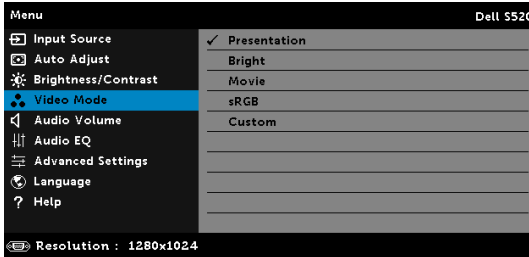

AUDIO VOLUME

The Audio Volume menu allows you adjust the **Audio**, **Microphone**, **Master** volume settings of your projector.

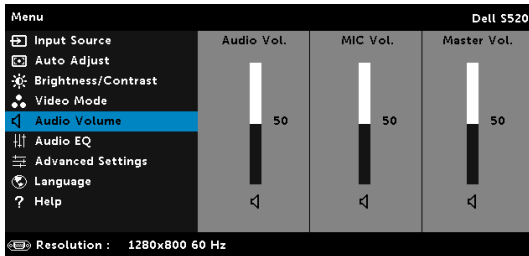

AUDIO VOLUME—Press to increase the audio volume and to decrease the audio volume.

MIC VOLUME—Press to increase the microphone volume and to decrease the microphone volume.

Master Volume—Press to increase the audio and microphone volume and decrease the audio and microphone volume.

AUDIO EQ

The Audio EQ menu allows you adjust the audio to boost or reduce (attenuating) the levels of different frequencies in a signal.

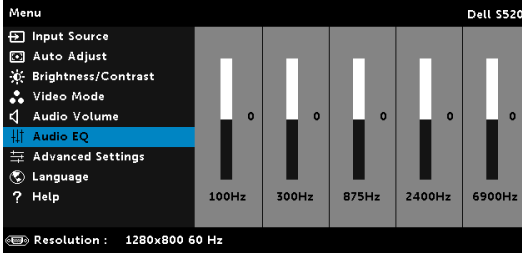

ADVANCED SETTINGS

The Advanced Settings menu allows you to change settings for **Image**, **Display**, **Projector**, **LAN**, **Wireless**, **Menu**, **Power**, **Interactive**, and **Information**.

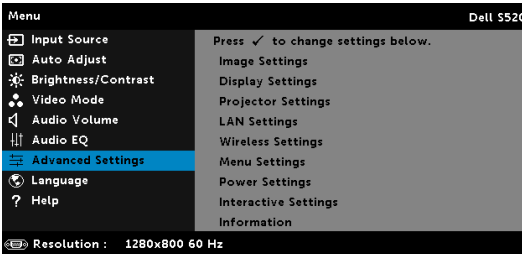

IMAGE SETTINGS (IN PC MODE)—Select and press to activate image settings. The image settings menu provides the following options:



COLOR TEMPERATURE—Allows you to adjust the color temperature. The screen appears cooler at higher color temperatures and warmer at lower color temperatures. When you adjust the values in the **Color Adjust** menu, the Custom mode is activated. The values are saved in the Custom mode.

RGB COLOR ADJUST—Allows you to manually adjust the colors red, green, and blue.

WHITE INTENSITY—Press and use and to display white intensity.

COLOR SPACE—Allows you to select the color space. The options are: RGB, YCbCr, and YPbPr.

VGA OUTPUT—Select On or Off the VGA output function at projector standby status. Default is Off.



NOTE: If you adjust the settings for **Color Temperature**, **RGB Color Adjust**, and **White Intensity** the projector automatically switches to **Custom mode**.

IMAGE SETTINGS (IN VIDEO MODE)—Select and press to activate image settings. The image settings menu provides the following options:

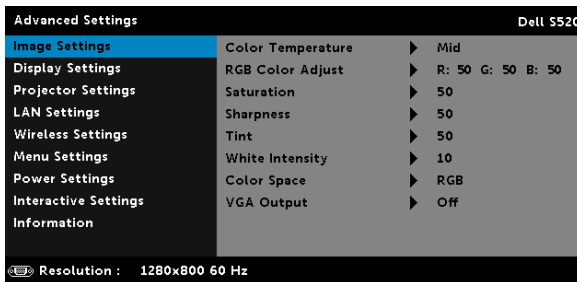

COLOR TEMPERATURE—Allows you to adjust the color temperature. The screen appears cooler at higher color temperatures and warmer at lower color temperatures. When you adjust the values in the **Color Adjust** menu, the Custom mode is activated. The values are saved in the Custom mode.

RGB COLOR ADJUST—Allows you to manually adjust the colors red, green, and blue.

SATURATION—Allows you to adjust the video source from black and white to fully saturated color. Press to increase the amount of color in the image and to decrease the amount of color in the image.

SHARPNESS—Press to increase the sharpness and to decrease the sharpness.

TINT—Press to increase the amount of green in the image and to decrease the amount of green in the image.

WHITE INTENSITY—Press and use and to display white intensity.

COLOR SPACE—Allows you to select the color space. The options are: RGB, YCbCr, and YPbPr.

VGA OUTPUT—Select On or Off the VGA output function at projector standby status. Default is Off.



NOTE:

- 1 If you adjust the settings for **Color Temperature, RGB Color Adjust, Saturation, Sharpness, Tint, and White Intensity** the projector automatically switches to Custom mode.
- 2 **Saturation, Sharpness, and Tint** only available when the input source is from Composite or S-Video.

IMAGE SETTINGS (NO INPUT SOURCE)—Select and press to activate image settings. The image settings menu provides the following options:

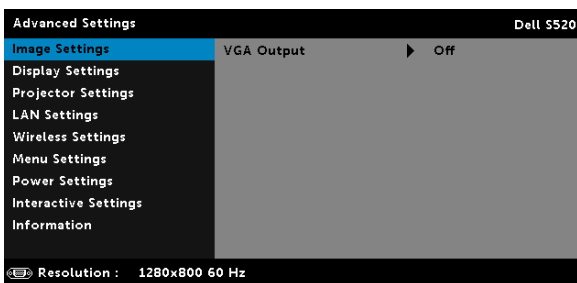

VGA OUTPUT—Select On or Off the VGA output function at projector standby status. Default is Off.

DISPLAY SETTINGS (IN PC MODE)—Select and press to activate display

settings. The display settings menu provides the following options:

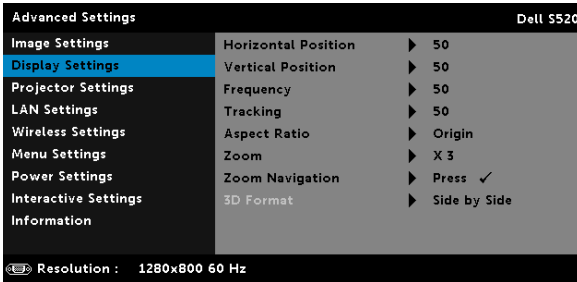

HORIZONTAL POSITION—Press to move the image right and to move the image left.

VERTICAL POSITION—Press to move the image up and to move the image down.

FREQUENCY—Allows you to change the display data clock frequency to match the frequency of your computer's graphics card. If you see a vertical flickering wave, use the Frequency control to minimize the bars. This is a coarse adjustment.

TRACKING—Synchronize the phase of the display signal with the graphic card. If you experience an unstable or flickering image, use Tracking to correct it. This is a fine adjustment.

ASPECT RATIO—Allows you to select the aspect ratio to adjust how the image appears. Options are: Origin, 16:10, and 4:3.

- Origin — Select Origin to maintain the aspect ratio of the image projector according to the input source.
- 16:10 — The input source scales to fit the width of the screen to project a 16:10 screen image.
- 4:3 — The input source scales to fit the screen and projects a 4:3 image.

Zoom—Press and to zoom and view the image.

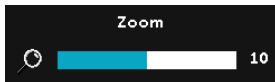

Adjust the image scale by pressing or and press to view on your remote control only.

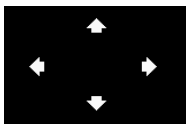

Zoom Navigation—Press to activate the Zoom Navigation menu.

Use , , , to navigate the projection screen.

3D FORMAT—Allows you to select the 3D format. Options are: Side By Side, Side By Side Full, Frame Sequential, Field Sequential, Top/Bottom, and Top/Bottom Full.

3D SYNC INVERT—If you see a discrete or overlapping image while wearing DLP 3D goggles, you may need to execute 'Invert' to get best match of left/right image sequence to get the correct image. (For DLP 3D goggles)

 **NOTE:**

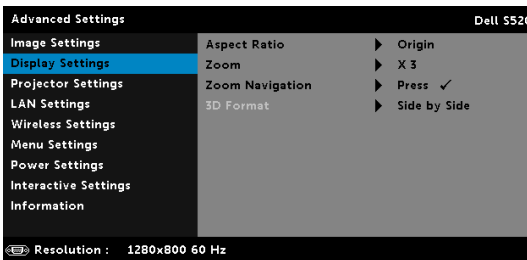

- 1 When you want to create a 3D experience, you will need a few other components including:
 - a "Active" 3D glasses with DLP Link™.
 - b 3D content. See "Note 2".
 - c 3D Player.
- 2 HDMI 1.4a 3D support and refresh rate are as below:
 - a 1280x720p@50 Hz Frame Packing
 - b 1280x720p@59.94/60 Hz Frame Packing
 - c 1920x1080p@23.98/24 Hz Frame Packing
 - d 1920x1080i@50 Hz Side by Side Half
 - e 1920x1080i@59.94/60 Hz Side by Side Half
 - f 1280x720p@50 Hz Top and Bottom
 - g 1280x720p@59.94/60 Hz Top and Bottom
 - h 1920x1080p@23.98/24 Hz Top and Bottom

DISPLAY SETTINGS (IN VIDEO MODE)—Select and press  to activate display settings. The display settings menu provides the following options:





ASPECT RATIO—Allows you to select the aspect ratio to adjust how the image appears. Options are: Origin, 16:10, and 4:3.

- Origin — Select Origin to maintain the aspect ratio of image projector according to the input source.
- 16:10 — The input source scales to fit the width of the screen to project a 16:10 screen image.
- 4:3 — The input source scales to fit the screen and projects a 4:3 image.

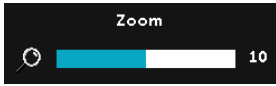



Zoom—Press  and  to zoom and view the image.

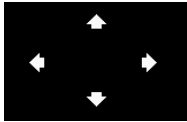

Adjust the image scale by pressing  or  and press  to view on your remote control only.



ZOOM NAVIGATION—Press  to activate the Zoom Navigation menu.

Use , , ,  to navigate the projection screen.

3D FORMAT—Allows you to select the 3D format. Options are: Side By Side, Side By Side Full, Frame Sequential, Field Sequential, Top/Bottom, and Top/Bottom Full.

3D SYNC INVERT—If you see a discrete or overlapping image while wearing DLP 3D goggles, you may need to execute 'Invert' to get best match of left/right image sequence to get the correct image. (For DLP 3D goggles)



NOTE:

- 1 When you want to create a 3D experience, you will need a few other components including:
 - a "Active" 3D glasses with DLP Link™.
 - b 3D content. See "Note 2".
 - c 3D Player.
- 2 HDMI 1.4a 3D support and refresh rate are as below:
 - a 1280x720p@50 Hz Frame Packing
 - b 1280x720p@59.94/60 Hz Frame Packing
 - c 1920x1080p@23.98/24 Hz Frame Packing
 - d 1920x1080i@50 Hz Side by Side Half
 - e 1920x1080i@59.94/60 Hz Side by Side Half
 - f 1280x720p@50 Hz Top and Bottom
 - g 1280x720p@59.94/60 Hz Top and Bottom

h 1920x1080p@23.98/24 Hz Top and Bottom

PROJECTOR SETTINGS—Select and press  to activate projector settings. The projector settings menu provides the following options:

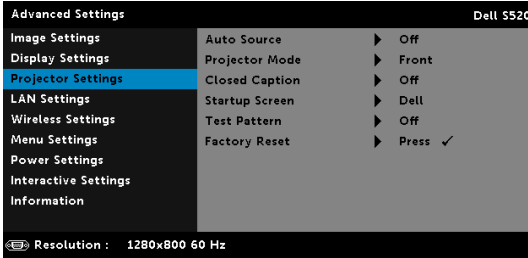

AUTO SOURCE—Select **Off** (the default) to lock the current input signal. If you press the Source button when the Auto Source mode is set to Off, you can manually select the input signal. Select **On** to auto detect the available input signals. If you press the Source button when the projector is on, it automatically finds the next available input signal.

PROJECTOR MODE—Allows you to select the projector mode, depending upon how the projector is mounted.

- Rear Projection-Wall Mount — The projector reverses and turns the image upside down. You can project from behind a translucent screen with a wall-mounted projection (for regular projection).
- Front Projection-Wall Mount — The projector turns the image upside down for wall-mounted projection.

CLOSED CAPTION—Select **On** to enable close caption and activate the closed caption menu. Select appropriate closed caption options: CC1, CC2, CC3, and CC4.

 **NOTE:**

- 1 Closed caption option is available for NTSC only.
- 2 Closed captioning can only be enabled via S-Video and Composite Video inputs.

STARTUP SCREEN—Default is Dell logo as wallpaper. You can also select Capture Screen option to capture the screen display. The following message appears on the screen.



 **NOTE:** To capture a full image, ensure that the input signal connected to the projector is at 1280 x 800 resolution.

TEST PATTERN—Test Pattern is used to test focus and resolution.

You can enable or disable the **Test Pattern** by selecting **Off**, **1**, or **2**.

Test Pattern 1:

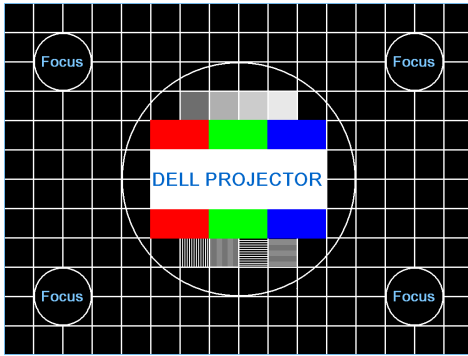

Test Pattern 2:

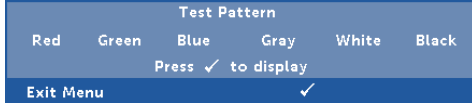

FACTORY RESET—Select Confirm and press  to reset all settings to its factory default. The below warning message appears:







Reset items include both computer sources and Video source settings.

LAN SETTINGS—Select and press  to activate LAN settings. The LAN settings menu provides the following options:



WIRELESS AND LAN—Select **Enabled** to activate the Wireless and LAN function.

DHCP—If a DHCP server exists in the network to which the projector is connected, the IP address will automatically be acquired when you select DHCP On. If DHCP is Off, manually set the IP Address, Subnet Mask, and Gateway. Use  and  to select the number of IP address, Subnet Mask, and Gateway. Key in enter to confirm each number and then use  and  to set the next item.

IP ADDRESS—Automatically or manually assigns the IP address to the projector connected to the network.









SUBNET MASK—Configure the Subnet Mask of the network connection.

GATEWAY—Check the Gateway address with your network/system administrator if you configure it manually.

DNS—Check the DNS Server IP address with your network/system administrator if you configure it manually.

STORE—Press  to save the changes made in network configuration settings.

 **NOTE:**

- 1 Use  and  button to select IP Address, Subnet Mask, Gateway, DNS, and Store.
- 2 Press the  button to enter IP Address, Subnet Mask, Gateway or DNS to set the value. (The selected option is highlighted in blue)
 - a Use  and  button to select the option.
 - b Use  and  button to set the value.
 - c After the setup is complete, press the  button to exit.

- 3 After the **IP Address**, **Subnet Mask**, **Gateway**, and **DNS** is set up, select **Store** and press  button to store the settings.
- 4 If you select **Store** without pressing the **Enter** button, the system will keep the original settings.

RESET—Press  to reset network configuration.

WIRELESS SETTINGS—Select and press  to activate wireless settings. The wireless settings menu provides the following options:

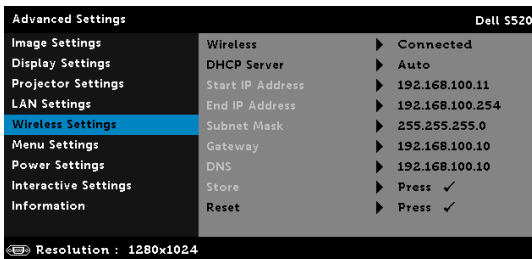

WIRELESS—If your projector wireless function is enabled, this option will be listed on the screen as Connected.

DHCP SERVER—Allows you to enable DHCP server of the wireless.

START IP ADDRESS—Automatically or manually assigns the Start IP address of the DHCP server to the projector connected to the wireless.

END IP ADDRESS—Automatically or manually assigns the End IP address of the DHCP server to the projector connected to the wireless.





SUBNET MASK—Configure the Subnet Mask of the wireless connection.

GATEWAY—Check the Gateway address with your network/system administrator if you configure it manually.

DNS—Check the DNS Server IP address with your network/system administrator if you configure it manually.

STORE—Press  to save the changes made in wireless configuration settings.

NOTE:

- 1 Use  and  button to select IP Address, Subnet Mask, Gateway, DNS, and Store.
- 2 Press the  button to enter IP Address, Subnet Mask, Gateway, or DNS to set the value. (The selected option is highlighted in blue)
 - a Use  and  button to select the option.

- b Use and button to set the value.
 - c After the setup is complete, press the button to exit.
- 3 After the **IP Address**, **Subnet Mask**, **Gateway**, and **DNS** is set up, select **Store** and press button to store the settings.
 - 4 If you select **Store** without pressing the **Enter** button, the system will keep the original settings.

RESET—Press to reset wireless configuration.

MENU SETTINGS—Select and press to activate the menu settings. The menu settings consists of the following options:

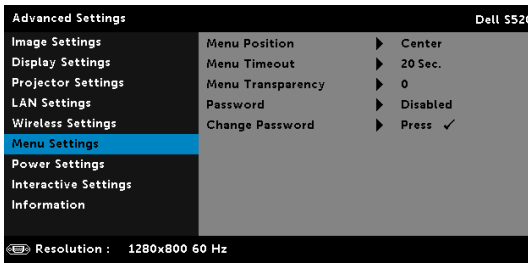

MENU POSITION—Allows you to change the position of the OSD menu on the screen.

MENU TIMEOUT—Allows you to adjust the time for an OSD timeout. By default, the OSD disappears after 20 seconds of non-activity.

MENU TRANSPARENCY—Select to change the transparency level of the OSD background.

PASSWORD—When Password Protect is enabled, a Password Protect screen requesting you to enter a password will be displayed when the power plug is inserted into the electrical output and the power for the projector is first turned on. By default, this function is disabled. You can enable this feature by selecting **Enabled**. If the password has been set before, key in the password first and select the function. This password security feature will be activated the next time you turn on the projector. If you enable this feature, you will be asked to enter the projector's password after you turn on the projector:

- 1 First time password input request:

- a Go to **Menu Settings**, press  and then select **Password** to enable the password settings.

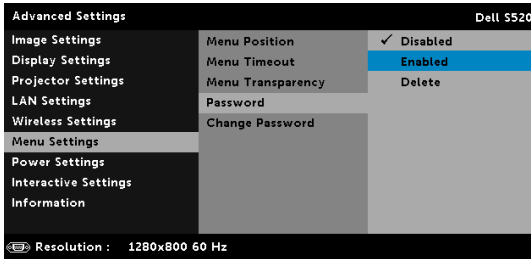

- b Enabling the Password function will pop up a change screen. Key in a 4-digit number from the screen and press .



- c To confirm, enter the password again.
- d If the password verification is successful, you may resume with accessing the projector's functions and its utilities.
- 2 If you have entered an incorrect password, you will be given two more chances. After three invalid attempts, the projector will automatically turn off.
-  **NOTE:** If you forget your password, contact DELL or a qualified service person.
- 3 To disable the password function, select the **Disabled** option to close the function.
- 4 To delete the password, select the **Delete** option.

CHANGE PASSWORD—Key in the original password. Then, enter the new password and confirm the new password again.

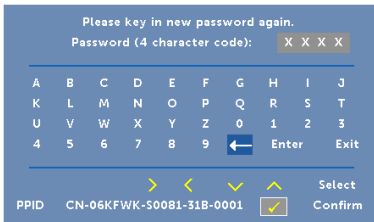
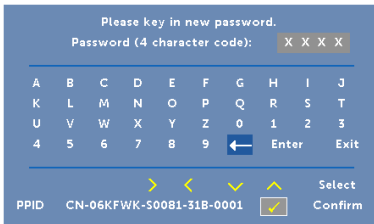
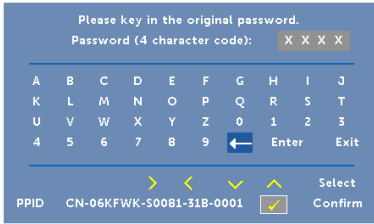

POWER SETTINGS—Select and press to activate power settings. The power settings menu provides the following options:

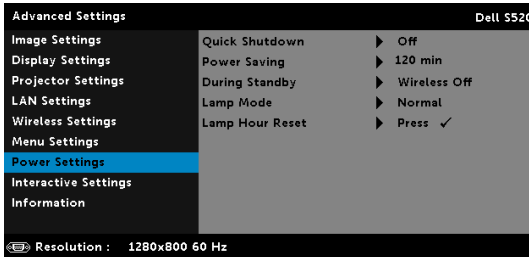

QUICK SHUTDOWN—Select On to turn off the projector with a single press of the Power button. This function allows the projector to quickly power off with an accelerated fan speed. Slightly higher acoustic noise is expected during quick power off.



NOTE: Before you turn on the projector again, wait for 60 seconds to allow the internal temperature to stabilize. The projector will take a longer time to turn on if you try to power on immediately. Its cooling fan will run at full speed for about 30 seconds to stabilize the internal temperature.

POWER SAVING—By default, the projector is set to enter power saving mode after 120 minutes of no activity. A warning message appears on screen showing a 60 seconds countdown before switching to power saving mode. Press any button during the countdown period to stop the power-saving mode.

You can also set a different delay period to enter power saving mode. The delay period is the time you want the projector to wait without an input signal.

If an input signal is not detected during the delay period, the projector turns off. To turn on the projector press the Power button.

DURING STANDBY—Select Wireless On or Off set the Wireless/LAN model on/off while the projector is standby status (default is Wireless Off).

LAMP MODE—Allows you to select the Normal, ECO, Dynamic, or Extreme Dimming mode.

Normal mode operates at full power level. ECO mode operates at a lower power level which may provide longer lamp life, quieter operation, and dimmer luminance output on the screen.

DYNAMIC—Select and press to activate dynamic feature.

EXTREME DIMMING—Select and press to activate extreme dimming feature.

LAMP HOUR RESET—Press and select the Confirm option to reset the lamp hour.

INTERACTIVE SETTINGS—Select and press  to activate Interactive settings. The Interactive settings menu provides the following options:

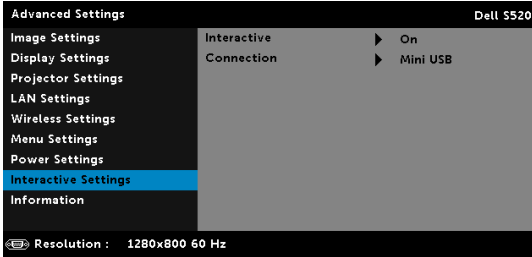

INTERACTIVE—Select **On** (the default) to turn on the DC power.

CONNECTION—Allows you to set the laser touch connector selection as **Mini USB** or **Wireless/LAN**.

INFORMATION—The information menu displays the current S520 projector settings.

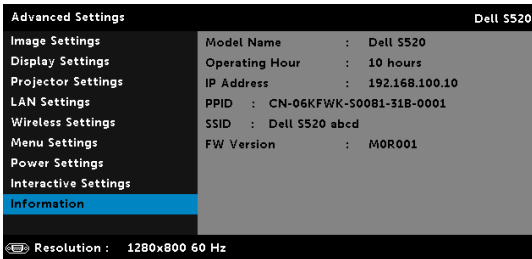

LANGUAGE

Allows you to set the language for the OSD. Press  to activate the Language menu.



HELP

If you encounter problems with your projector, you can access the help menu for troubleshooting.

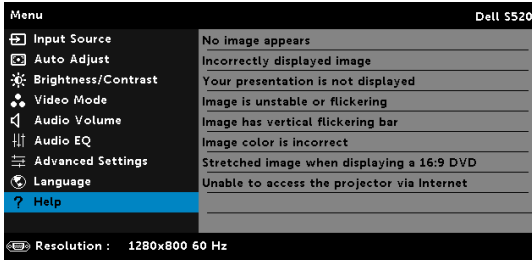

Multimedia Introduction

Multimedia format supported:

Photo Format

Image Type (Ext Name)	Sub Type	Encode Type	Max Pixels
GIF			8000 x 8000
PNG			8000 x 8000
BMP			8000 x 8000
JPEG/JPG	Baseline	YUV420	8000 x 8000
		YUV422	
		YUV440	
		YUV444	
	Progressive	YUV420	8000 x 8000
		YUV422	
		YUV440	
		YUV444	

Video Format

File Format	Max. Resolution	Max. Bit Rate (bps)	Max. Display	Audio Format
Motion JPEG	1920 x 1080, 30fps	20 Mbps	1080p, 60 Hz	LPCM
AVI	1920 x 1080, 30fps	20 Mbps	1080p, 60 Hz	MPEG-1 Layer 3
MPEG-4	1920 x 1080, 30fps	20 Mbps	1080p, 60 Hz	
MOV	1920 x 1080, 30fps	20 Mbps	1080p, 60 Hz	
ASF	1920 x 1080, 30fps	20 Mbps	1080p, 60 Hz	
MKV	1920 x 1080, 30fps	20 Mbps	1080p, 60 Hz	
WMV	1920 x 1080, 30fps	20 Mbps	1080p, 60 Hz	WMA

Music Format

Music Type (ext Name)	Max. Sample Rate (KHz)	Max. Bit Rate (Kbps)
LPCM	48 KHz	320 Kbps
MPEG-1 Layer 3	48 KHz	320 Kbps
WMA	48 KHz	320 Kbps
WAV	48 KHz	320 Kbps
OGG	48 KHz	320 Kbps

How to set-up File Type for Multimedia with USB

 **NOTE:** A USB flash disk must be plugged into the projector if you want to use the multimedia USB function.

Follow these steps to playback the Photo, Video, or Music files on your projector:

- 1 Connect the power cable and turn on the projector by pressing the power button.

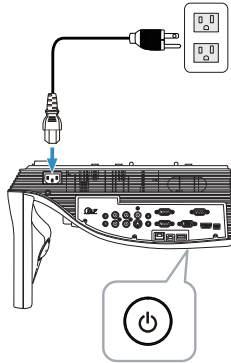

- 2 Plug in a **USB flash disk** to your projector.

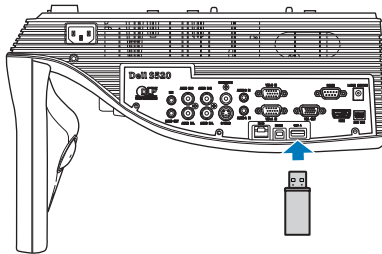

- 3 Press the **Menu** button on the remote control.

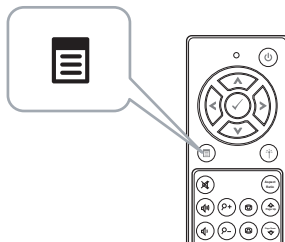

- 4 Access the **Input Source** menu, select **Wireless/USB** and then select **USB Viewer** on the sub-menu.

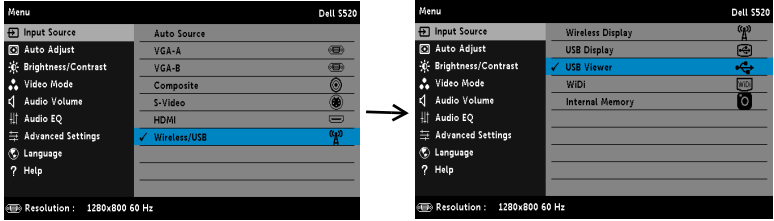

The **USB Screen** shown below appears:

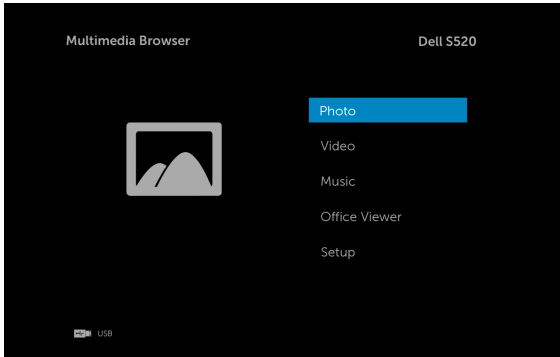

- 5 Select the multimedia files: **Photo**, **Video**, **Music**, or **Office Viewer**, and then press the  to start playing. Or select the **Setup** option to change multimedia settings. See "Multimedia Setup" on page 61.

How to set-up File Type for Multimedia with Internal Memory

Follow these steps to playback the Photo, Video, or Music files on your projector:

- 1 Connect the power cable and turn on the projector by pressing the power button.

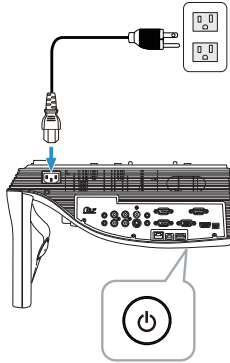

- 2 Press the **Menu** button on the remote control.

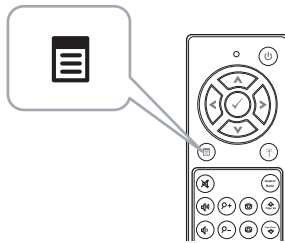

- 3 Access the **Input Source** menu, select **Wireless/USB** and then select **Internal Memory** on the sub-menu.

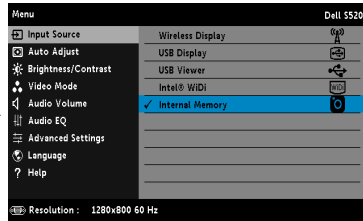
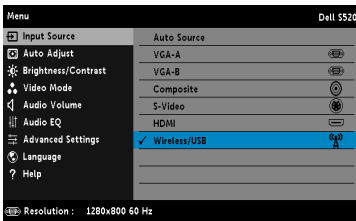

The **Internal Memory Screen** shown below appears:

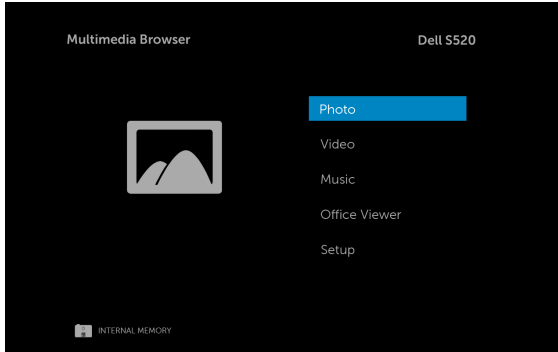

- 4 Select the multimedia files: **Photo**, **Video**, **Music**, or **Office Viewer**, and then press the  to start playing. Or select the **Setup** option to change multimedia settings. See "Multimedia Setup" on page 61.





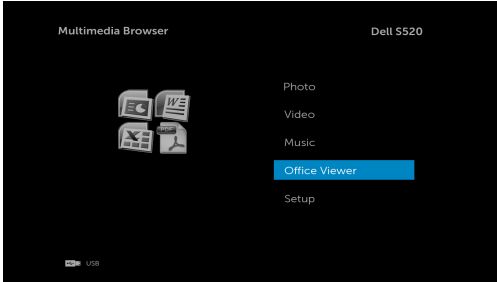

Office Viewer for the USB and Internal Memory

The Office Viewer feature allows you to use MS Excel, MS Word, MS PowerPoint, and PDF files.



Buttons Introduction

Use the up, down, left, and right buttons for navigation and  button on the remote control to select.

Button	Up 	Down 	Left 	Right 	Enter 	Menu 
	No function	No function	Previous page	Next page	No function	Back to previous menu

Multimedia SETUP for USB and Internal Memory

The multimedia setup menu allows you to change settings for Photo, Video, and Music.



NOTE: Multimedia setup menu and set are the same for the USB and internal memory.

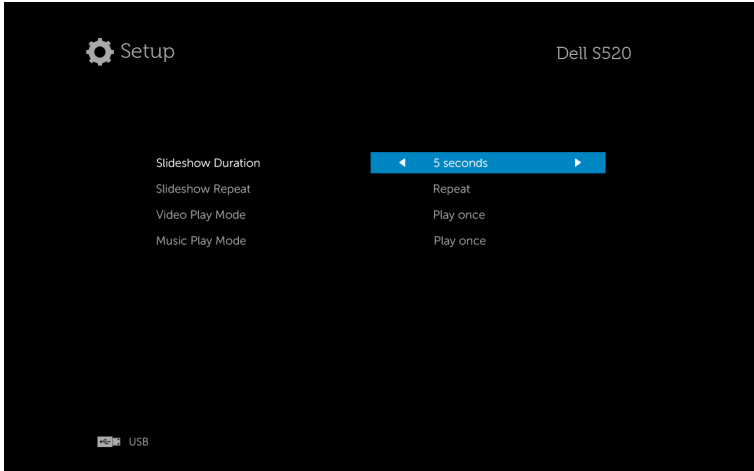

SLIDESHOW DURATION—Press \leftarrow or \rightarrow to select slideshow display interval. The image will automatically switch to the next photo after the time out. Options are: 5 seconds, 10 seconds, 30 seconds, and 1 minute.

SLIDESHOW REPEAT—Press \leftarrow or \rightarrow to select slideshow repeat as Repeat or No Repeat.

VIDEO PLAY MODE—Press \leftarrow or \rightarrow to select movie play mode. Options are: **Play once**, **Repeat item**, **Repeat folder**, and **Shuffle**.

MUSIC PLAY MODE—Press \leftarrow or \rightarrow to select movie play mode. Options are: **Play once**, **Repeat item**, **Repeat folder**, and **Shuffle**.

Intel® Wireless Display (WiDi) Installation



NOTE: Your computer must have the following Intel® Wireless Display system requirements:

System Component	Requirement
Processor	<p>ONE of the following mobile processors:</p> <p>3rd generation Intel® Core™ Processor: all mobile processors</p> <p>3rd Generation Intel® Core™ i7 Processor: 640M; 660LM; 640LM; 620LM; 620M; 610E; 690UM; 680UM; 660UM; 640UM; 620UM; 660UE; 3610QM; 3770T; 3820QM; 3840QM; 2710QE; 2820QM; 2720QM; 2635QM; 2630QM; 2657M; 2649M; 2629M; 2620M; 2617M; 2540M; 2520M; 2510E; 2640LM; 2620LM; 2630UM; 2610UM; 2530UM; 2920XM</p> <p>3rd Generation Intel® Core™ i5 Processors: 580M; 560M; 540M; 520M; 480M; 460M; 450M; 430M; 580UM; 560UM; 540UM; 520UM; 470UM; 430UM; 2540M; 2520M; 2410M; 2537M; 2430M; 2435M, 2450M; 2467M</p> <p>3rd Generation Intel® Core™ i3 Processors: 390M; 380M; 370M; 350M; 330M; 330E; 3110M; 3120M; 3240; 3240T; 3217U; 3225; 3229Y; 3220; 3220T; 2310E; 2310M; 2312M; 2328M; 2330E; 2330M; 2340UE; 2348M; 2350M; 2357M; 2365M; 2367M; 2370M; 2377M</p>
Graphics	Intel® HD Graphics

Wireless	<p>ONE of the following:</p> <p>Intel® Centrino® Wireless-N 1000, 1030, 2200, or 2230</p> <p>Intel® Centrino® Wireless-N 2200 for Desktop</p> <p>Intel® Centrino® Advanced-N 6200, 6205, 6230, or 6235</p> <p>Intel® Centrino® Advanced-N 6205 for Desktop</p> <p>Intel® Centrino® Wireless-N + WiMAX 6150</p> <p>Intel® Centrino® Advanced-N + WiMAX 6250</p> <p>Intel® Centrino® Ultimate-N 6300</p>
Software	<p>Intel® My Wi-Fi Technology (Intel® MWT) and Intel® Wireless Display must be pre-installed and enabled.</p>
Operating System	<p>Windows 7 (64-bit), Home Premium, Ultimate or Professional</p> <p>Windows 7 (32-bit), Home Premium, Ultimate, Professional or Basic</p> <p>Windows 8 32-bit and 64-bit editions</p>

For more information, see the Intel® WiDi website at:
www.intel.com/go/widi.



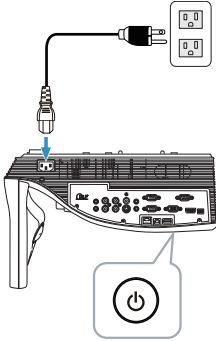

Enable Intel® WiDi on the Projector

- 1 Connect the power cable and press the power button.

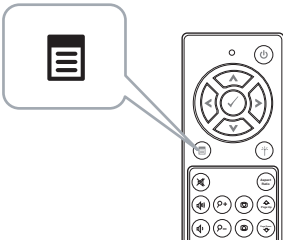

- 2 Press the **Menu** button on the remote control.



NOTE: Use , , , and  buttons to navigate and  to select.

- 3 Access the **Input Source** menu, select **Wireless/USB** and then select **Intel® WiDi** on the sub-menu.

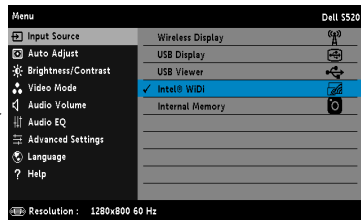
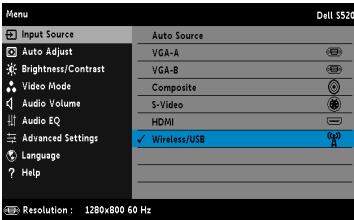

The **Intel® WiDi Guide Screen** shown below appears:

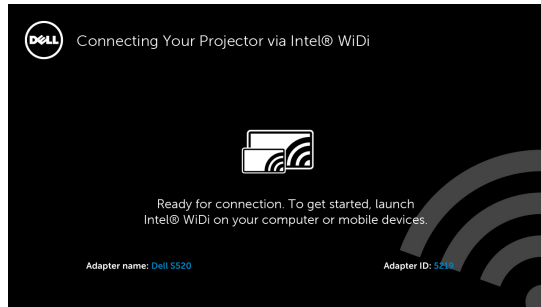

- 4 Take note of the **ADAPTER NAME** and **PIN CODE**. You will need this information to log in later.

Launch the Intel® WiDi on Your Computer

- 5 Type WiDi in your Windows search bar. If your computer has built-in Intel® WiDi, you will see the "Intel® WiDi" application in your search results.
- 6 Connect your computer to Dell S520.

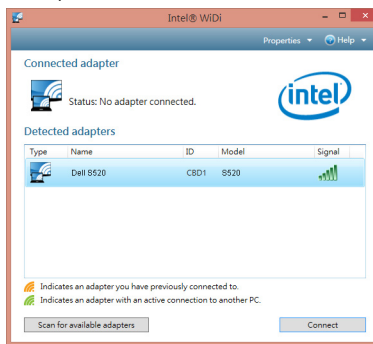

Login

Login with the PIN Code provided in Step 4 of Intel® Wireless Display (WiDi) Installation, then click OK.

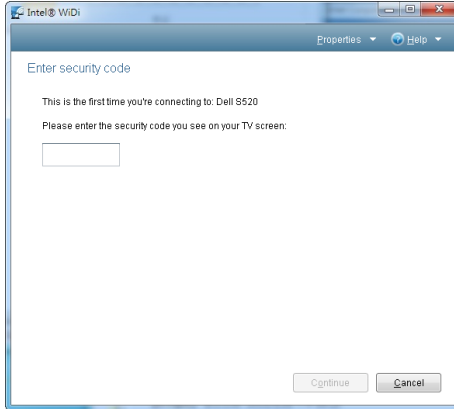

Wireless Display or LAN Display Installation



NOTE: Your computer must have the following minimum system requirements:

Operating System:

- Windows
Microsoft Windows XP Home or Professional Service pack 2 (32-bit recommended), Windows Vista 32-bit, and Windows 7 Home or Professional 32-bit or 64-bit, Windows 8 32-bit or 64-bit
- MAC
MacBook and above, MacOS 10.5 and above

Minimum Hardware:

- a** Intel Dual Core 1.4 MHz or higher
- b** 256 MB of RAM required, 512 MB or more recommended
- c** 10 MB of available hard-disk space
- d** nViDIA or ATI graphic card with 64 MB VRAM or above
- e** Ethernet adapter (10 / 100 bps) for an Ethernet connection
- f** A supported WLAN adapter for a WLAN connection (any NDIS-compliant 802.11b or 802.11g or 802.11n Wi-Fi device)

Web browser

Microsoft Internet Explorer 6.0 or 7.0 (recommended) or 8.0, Firefox 2.0, Safari 3.0, and above

Enable Wireless or LAN on the Projector

- 1 Connect the power cable and press the power button.

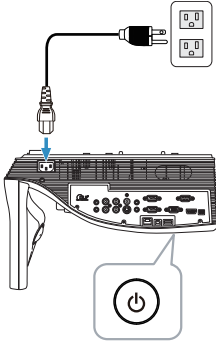

- 2 Press the **Menu** button on the remote control.

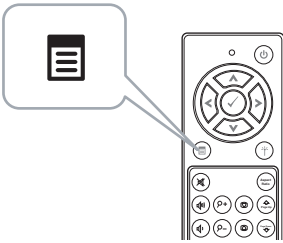

NOTE: Use , ,  and  buttons to navigate and  to select.

- 3 Access the **Input Source** menu, select **Wireless/USB** and then select **Wireless Display** on the sub-menu.

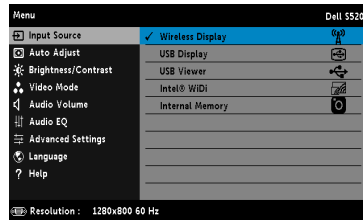
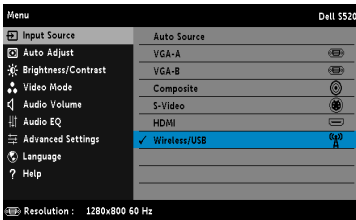

The **Wireless Guide Screen** shown below appears:

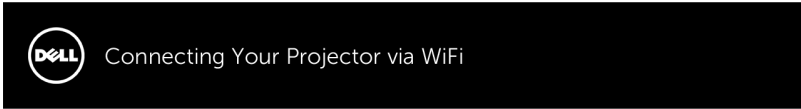

For First-time Connection



1. Connect your computer to the projector's wireless network (SSID):

Dell S520 abcd



2. Open web browser and enter the IP Address into your browser's address bar:

192.168.100.10



3. Click on 'Download' and run the installation program

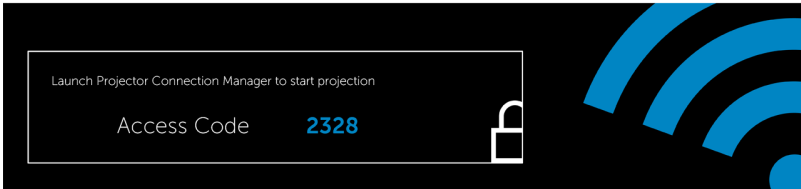

- 4 Take note of the **Wireless Network (SSID)**, **IP Address**, and **Access Code**. You will need this information to log in in later.

Install the Dell Projector Connection Manager on Your Computer

- 5 Connect your computer to the **Dell S520 abcd** wireless network.

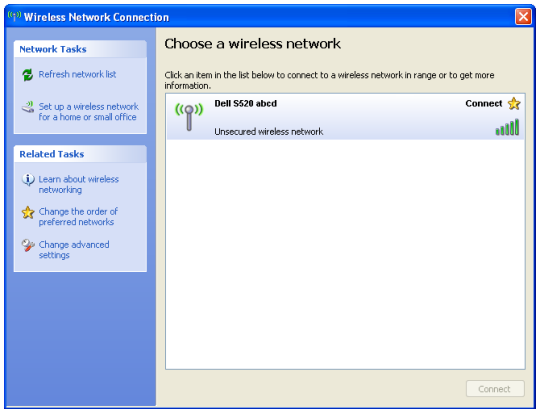

NOTE:

- Your computer must have wireless network function to detect the connection.
- When you connect to the Dell S520 abcd wireless network, you will lose wireless connectivity with other wireless networks.



NOTE: Remember to turn off all proxies. (In Microsoft® Windows Vista: Click **Control Panel** → **Internet Options** → **Connections** → **LAN Settings**)

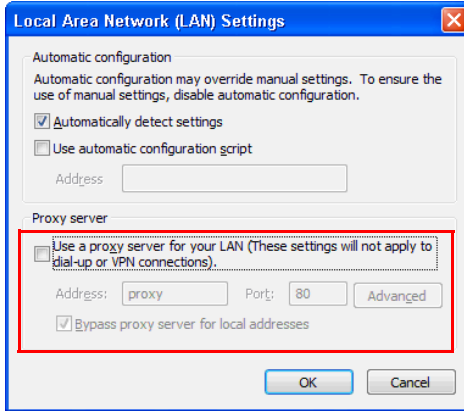

- 6 Open your internet browser. You will be automatically directed to the **S520 Web Management** web page.



NOTE: If the web page does not load automatically, enter the IP address (default IP address is 192.168.100.10) noted from the projector's screen in the browser's address bar.

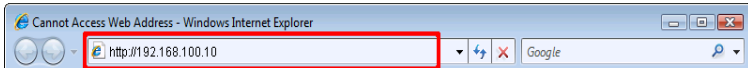

- 7 The S520 Web Management page opens. For first-time use, click **Download**.

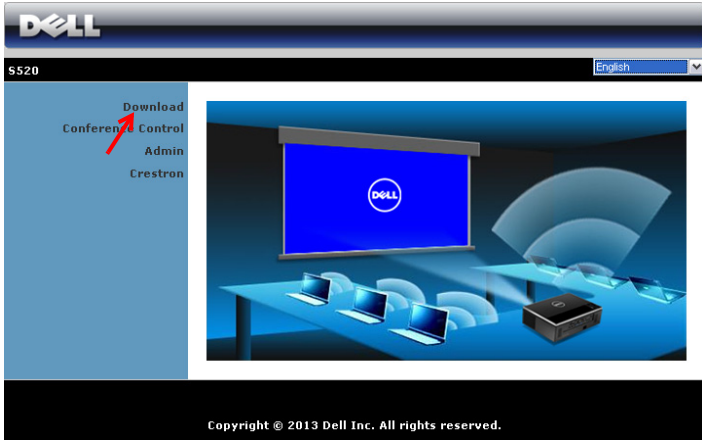

- 8 Select the appropriate operating system, then click **Download**.

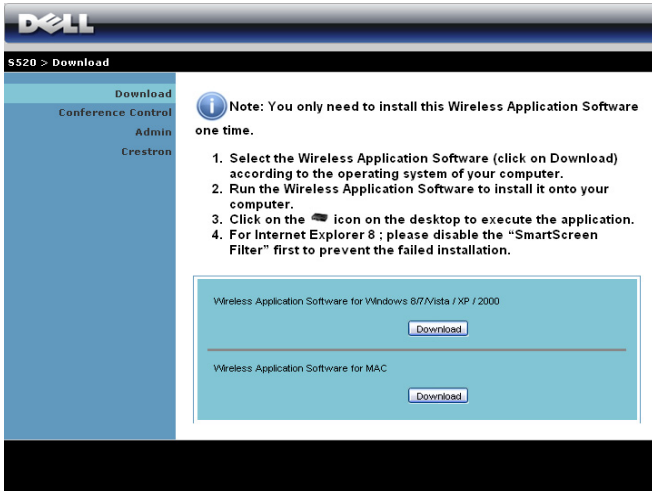

- 9 Click **Run** to proceed with the one-time installation of the software.



NOTE: You may choose to save the file and install it at a later time. To do this, click **Save**.

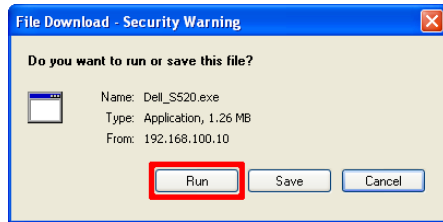

NOTE: Audio projection function needs installation of extra driver only in Windows XP. If your computer does not have the driver installed, a pop-up message will appear on-screen prompting you to install the required driver. You can download the “**Audio Projection Driver**” from the Dell Support site at dell.com/support



NOTE: If you are unable to install the application because of inadequate rights on the computer, please contact your network administrator.

- 10 The installation software will launch. Follow the on-screen instruction to complete setup.

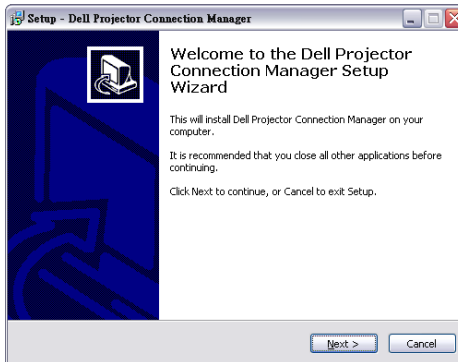



NOTE: For LAN display, connect the LAN cable to the projector and the computer.

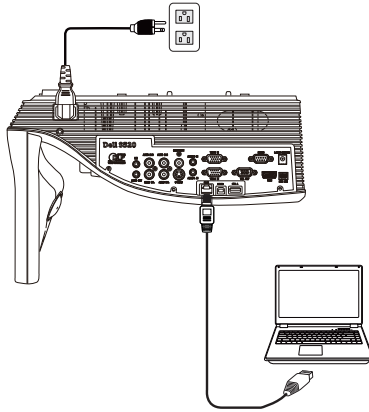

Launch the Dell Projector Connection Manager (for Wireless Display)

Once the installation is complete, the program will launch and search automatically. If the program does not launch automatically, you can double-click the  icon on the desktop to start the application.

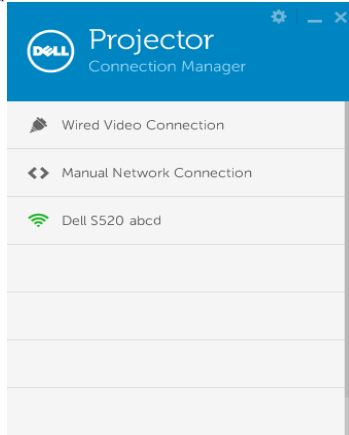

Login

Login with the Access Code provided in Step 4 of Wireless Display or LAN Display Installation, then click OK.

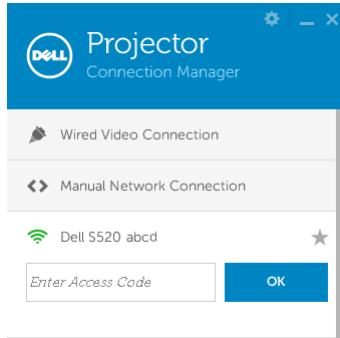

Launch the Dell Projector Connection Manager (for LAN Display)

Once the installation is complete, the program will launch and search automatically. If the program does not launch automatically, you can double-click the  icon, on the desktop to start the application.

- a Click the **"Manual Network Connection"** (Fig.1).
- b Enter **IP Address** (Fig.2, default IP address: 192.168.100.10).
- c Enter **Access Code** (Fig.3).

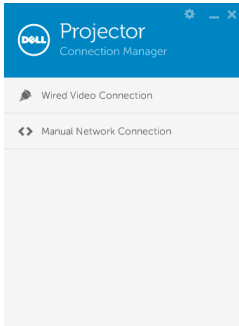

(Fig.1)

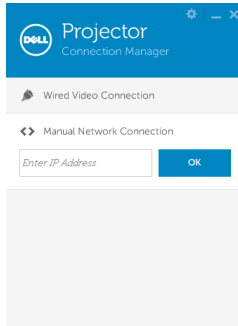

(Fig.2)

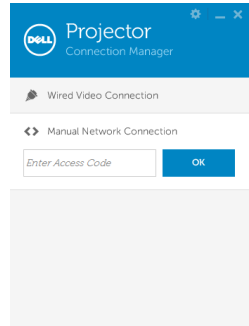







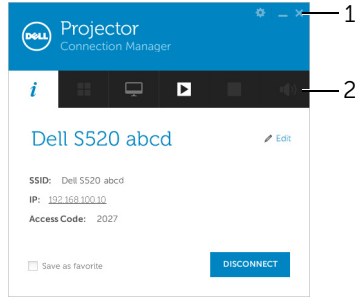



(Fig.3)

Understanding the Buttons

After a successful log in, the following screen appears:



Item	Description	
1	Status Bar	
	Settings	Click to activate the application settings.
	Minimize button	Click to minimize the application.
	Close button	Click to exit the application.
2	Controls Toolbar	
	Information	Click to display SSID, IP, and Access Code information.
	Share mode	Click to activate the share mode.
	Display mode	Click to change the display mode.
	Start	Click to start projection.
	Pause	Click to pause projection.
	Stop	Click to stop projection.
	Audio	Click to toggle audio projection On/Off.

Using the Settings

Click  to display the settings menu.

RESOLUTION—Allows you to setup the resolution.

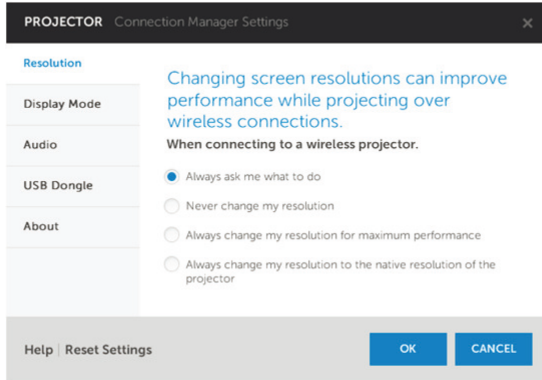

DISPLAY MODE—Allows you to setup the default projection mode.

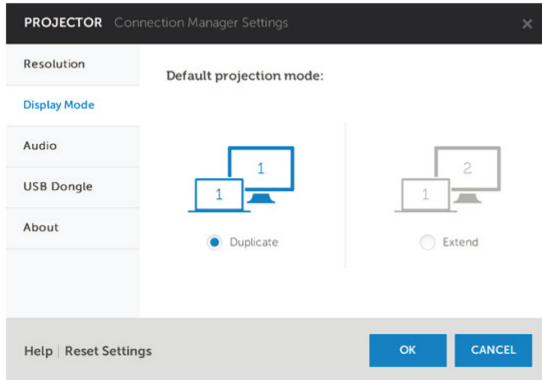

AUDIO—Allows you to change the audio settings.

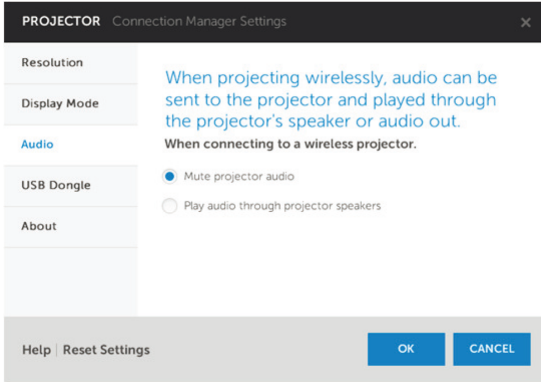

USB DONGLE—Allows you to create USB dongle. See "Make Application Token" on page 106.

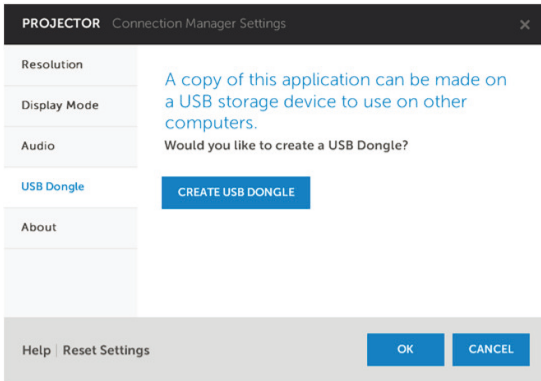

ABOUT—Display the application version.

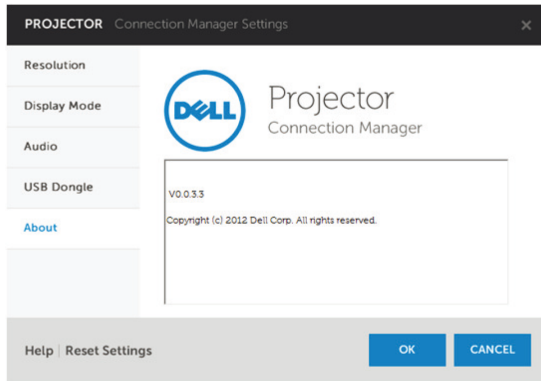

Audio Projection Installation

Audio Projection only supports the **Wireless Display** and **LAN Display** input source.

Minimum system requirements are as follow:

Operating System:

- Windows
Microsoft Windows XP™ Home or Professional Service pack 2/3 (32-bit recommended), Windows Vista 32-bit, or Windows® 7 Home or Professional 32-bit or 64-bit, Windows 8 32-bit or 64-bit
- MAC
MacBook Pro and above, MacOS 10.5 and above

Minimum Hardware:

- a Intel® Core™ i5-460 MHz (2.53 GHz/Turbo 2.8 GHz) or greater
- b 1 GB DDR3 VRAM independent graphics card or more recommended
- c 2 GB dual channel DDR3 SDRAM memory at 1066 MHz required or more recommended
- d Gigabit Ethernet
- e Integrated 802.11 a/b/g/n Wi-Fi Device for a WLAN connection



NOTE: If your computer does not meet the minimum hardware requirements, audio projection may have lag or noise. Meet the recommended system requirements to have optimized performance of audio projection.



NOTE: Audio projection function needs install extra driver only in Windows XP, If your computer does not have the driver installed, a pop-up message will appear on-screen prompting you to install the required driver. You can download the "**Audio Projection Driver**" from the Dell Support site at dell.com/support.



NOTE: Audio Projection function needs installed extra driver in MAC operating system. If your MAC computer does not have the driver installed, a pop-up message will appear on-screen prompting you to install the required driver. You can download the "**Soundflower Driver**" from the some search engine sites (ex. Yahoo, MSN...). The "**Soundflower Driver**" is a free application.



NOTE: Ports / Protocol for connection to the projector for projection via Ethernet:

UDP:	1047,	(backup: 1048, 1049)
TCP:	3268, 515, 1688, 1041	(backup: 389, 8080, 21)

Enable Wireless or LAN on the Projector.

- 1 Connect the power cable and turn on the projector by pressing the power button

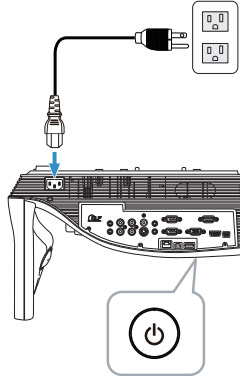

- 2 Press the **Menu** button on the remote control.

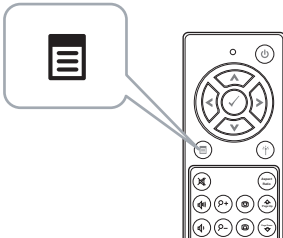

- 3 Access the **Input Source** menu, select the **Wireless/USB** and then select the **Wireless Display** on the sub-menu.

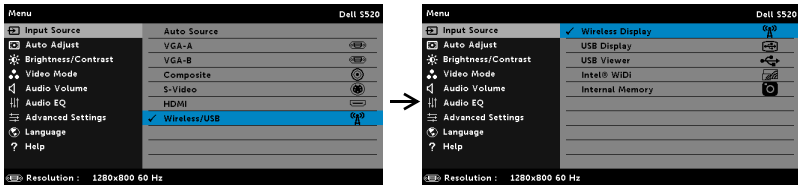

The Wireless Guide Screen shown below appears:

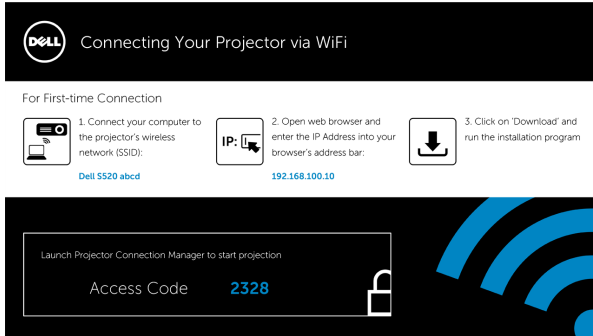

- 4 Take note of the **Wireless Network (SSID)**, **IP Address**, and **Access Code**. You will need this information to log in later.

Install the Dell Projector Connection Manager on Your Computer

- 5 "Dell Projector Connection Manager" is required if the Wireless or LAN is used for the Audio Projection set-up. Please download and install the software the first time you use Audio Projection. If it is already installed, skip **Step 5 - 6**.



NOTE: You only need to install the "Dell Projector Connection Manager Software" once.

- 6 Dell Projector Connection Manager Software download and install steps refer to steps 6 to 10 of the "Wireless Display or LAN Display Installation" on page 67. **Go to Step 7**.



NOTE: If the LAN is used for audio projection, connect the LAN cable to the projector and the computer. **Go to Step 9.**

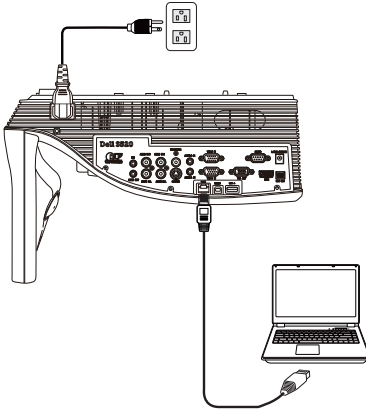

Launch the Dell Projector Connection Manager with Wireless Audio Projection

- 7 Once the installation is complete, the program will launch and search automatically. If the program does not launch automatically, you can double-click the  icon on the desktop to start the application. Select the **Dell S520 abcd** and then click the OK.

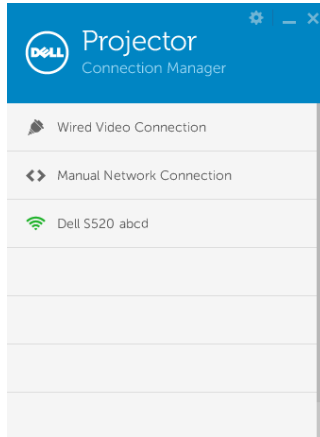

- 8 Login with the **Access Code** provided in Step 4 of Audio Projection Installation, then click OK. **Go to Step 10.**

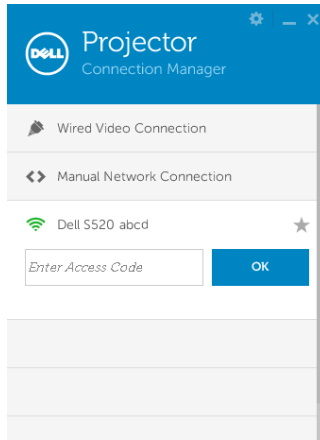

Launch the Dell Projector Connection Manager with LAN Audio Projection

- 9 Once the installation is complete, the program will launch and search automatically. If the program does not launch automatically, you can double-click the  icon, on the desktop to start the application.
- a Click the "**Manual Network Connection**" (Fig.1).
 - b Enter **IP Address** (Fig.2, default IP address: 192.168.100.10).
 - c Enter **Access Code** (Fig.3).

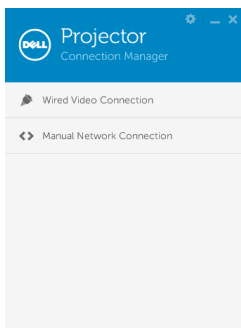

(Fig.1)

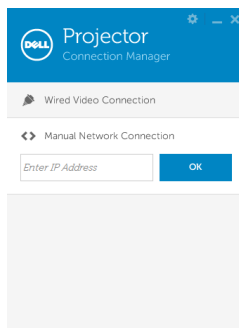

(Fig.2)

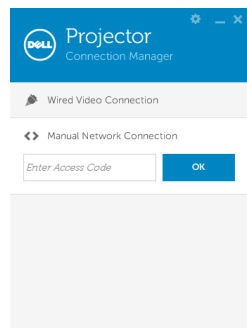

(Fig.3)

Using the Audio Projection

- 10 You are now logged into the Dell Projector Connection Manager. Click the "Play" button in the application to starting the LAN or wireless audio projection.

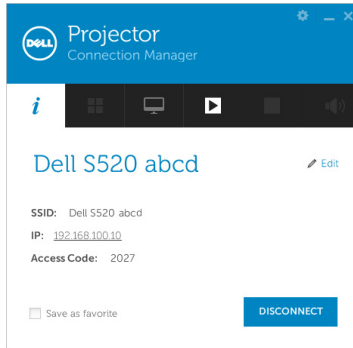

- 11 Click the "Audio Projection" button in the application to enable audio projection function

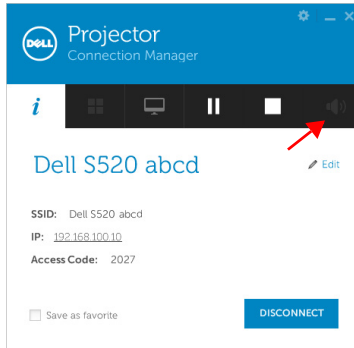

-  **NOTE:** Audio projection function needs installation of extra driver only in Windows XP. If your computer does not have the driver installed, a pop-up message will appear on-screen prompting you to install the required driver. You can download the "Audio Projection Driver" from the Dell Support site at dell.com/support.

- 12** Executing the Windows Media Player or others audio player software (example: Winamp player...) on your computer.



Managing the Projector From Web Management

Configuring the Network Setting

If the projector is connected to a network, you can access the projector using a web browser. For configuring the network setting, refer to "LAN Settings" on page 46.

Accessing Web Management

Use Internet Explorer 6.0 and above or Firefox 2.0 and above and enter the IP address. You can now access Web Management and manage the projector from a remote location.

Home Page



- Access the Web Management Home page by entering the projector's IP address at the web browser. See "LAN Settings" on page 46.
- Select the language for web management from the list.
- Click any menu item on the left tab to access the page.

Download the Dell Projector Connection Manager

See also "Wireless Display or LAN Display Installation" on page 67.

The screenshot shows a Dell website interface. At the top left is the Dell logo. Below it, the breadcrumb "S520 > Download" is visible. A left-hand navigation menu lists "Download", "Conference Control", "Admin", and "Crestron", with "Download" highlighted. The main content area features a blue information icon followed by a note: "Note: You only need to install this Wireless Application Software one time." Below the note is a numbered list of four instructions: 1. Select the Wireless Application Software (click on Download) according to the operating system of your computer. 2. Run the Wireless Application Software to install it onto your computer. 3. Click on the [application icon] icon on the desktop to execute the application. 4. For Internet Explorer 8; please disable the "SmartScreen Filter" first to prevent the failed installation. Below the list is a light blue box containing two download options: "Wireless Application Software for Windows 8/7/Vista / XP / 2000" with a "Download" button, and "Wireless Application Software for MAC" with a "Download" button.

Click the **Download** button of the corresponding operating system of your computer.

Managing Properties

Admin

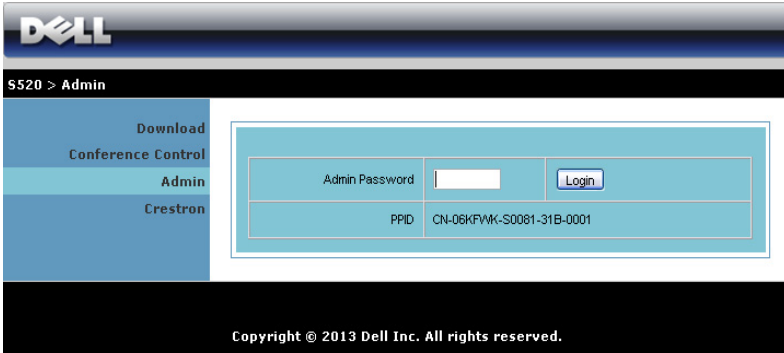

S520 > Admin

Download
Conference Control
Admin
Crestron

Admin Password	<input type="password"/>	Login
PPID	CN-06KPYMK-S0081-31B-0001	

Copyright © 2013 Dell Inc. All rights reserved.

An administrator password is required to access the Admin page.

- **Admin Password:** Enter the administrator password and then click **Login**. The default password is "admin". To change the password, see "Change Passwords" on page 95.

System Status

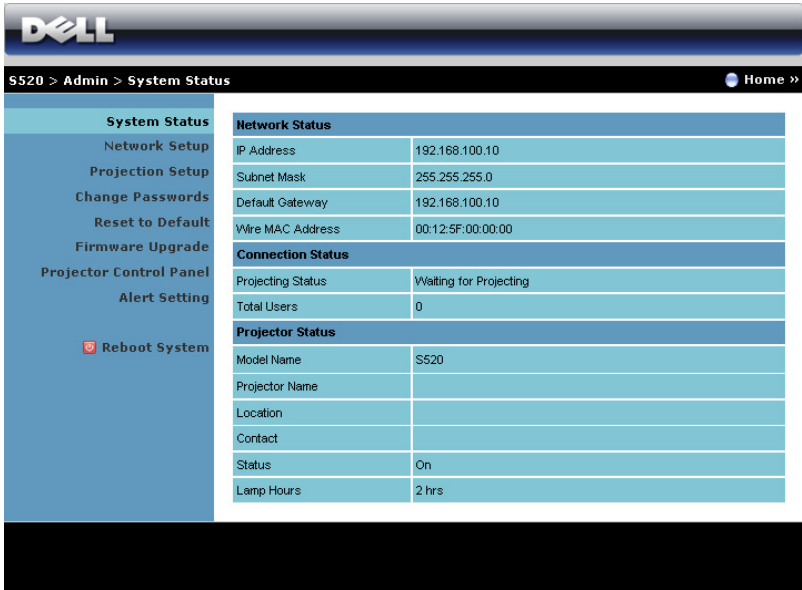

DELL

S520 > Admin > System Status Home »

System Status	
Network Setup	Network Status
Projection Setup	IP Address: 192.168.100.10
Change Passwords	Subnet Mask: 255.255.255.0
Reset to Default	Default Gateway: 192.168.100.10
Firmware Upgrade	Wire MAC Address: 00:12:5F:00:00:00
Projector Control Panel	Connection Status
Alert Setting	Projecting Status: Waiting for Projecting
Reboot System	Total Users: 0
	Projector Status
	Model Name: S520
	Projector Name:
	Location:
	Contact:
	Status: On
	Lamp Hours: 2 hrs

Displays the **Network Status**, **Connection Status**, and **Projector Status** information.

Network Status

See OSD section on page 46.

5520 > Admin > Network Setup Home »

System Status
Network Setup
Projection Setup
Change Passwords
Reset to Default
Firmware Upgrade
Projector Control Panel
Alert Setting
 Reboot System

IP Setup
 Obtain an IP address automatically Use the following IP address
IP Address: 192 . 168 . 100 . 10
Subnet Mask: 255 . 255 . 255 . 0
Default Gateway: 192 . 168 . 100 . 10
DNS Server: 192 . 168 . 100 . 10

DHCP Server Setup
 Auto Disable
Start IP: 192 . 168 . 100 . 11
End IP: 192 . 168 . 100 . 254
Subnet Mask: 255 . 255 . 255 . 0
Default Gateway: 192 . 168 . 100 . 10
DNS Server: 192 . 168 . 100 . 10

Wireless Setup
Wireless LAN: Enable Disable
Region: ---- WORLDWIDE ----
SSID: Dell S520 Interactive Touch
SSID Broadcast: Enable Disable
Frequency Band: 2.4 GHz 5 GHz
Channel: Auto
Encryption: Disable
Key: _____

RADIUS Server Setup
IP Address: 192 . 168 . 100 . 10
Port: 1812
Key: _____

GateKeeper
 All Pass All Block Internet Only

Set Security For SHMP
Write Community: _____

IP Setup

- Choose **Obtain an IP address automatically** to assign an IP address to the projector automatically, or **Use the following IP address** to assign an IP address manually.

DHCP Server Setup

- Choose **Auto** to automatically set up the **Start IP**, **End IP**, **Frequency Band**, **Subnet Mask**, **Default Gateway**, and **DNS Server** address from a DHCP server, or **Disable** to disable this function.

Wireless Setup

- Choose **Enable** to set up the **Region, SSID, SSID Broadcast, Frequency Band, Channel, Encryption, and Key**. Choose **Disable** to disable the wireless set up.

SSID: Up to maximum length of 32 characters.

Encryption: You can disable WPA key or select one of 64-bit or 128-bit in ASCII or HEX string.

Key: If Encryption is enabled, you have to set key value according to the Encryption mode you selected.

RADIUS Server Setup

- Set up the IP address, Port, and Key information.

GateKeeper

- There are three options:

All Pass: Allow users to access the office network via the wireless projector.

All Block: Block users from accessing the office network via the wireless projector.

Internet Only: Block users from the office network, but still reserve Internet connection capability.

Set Security For SNMP

- Setup Write Community information.

Click the **Apply** button to save and apply changes. The projector must be restarted for the changes to take effect.

Projection Setup

S520 > Admin > Projection Setup Home »

System Status Network Setup Projection Setup Change Passwords Reset to Default Firmware Upgrade Projector Control Panel Alert Setting Reboot System	Projection Setup	Resolution	WXGA (1280x800) ▾
		Login Code	<input type="radio"/> Disable <input checked="" type="radio"/> Random <input type="radio"/> Use the following code <input type="text"/>
		<input type="button" value="Apply"/> <input type="button" value="Cancel"/>	

Projection Setup

- **Resolution:** Allows you to select the resolution. Options are: XGA (1024 x 768) and WXGA (1280 x 800).
- **Login Code:** Select how you want the login code to be generated by the projector. There are three options:
 - **Disable:** Login code will not be required when logging in to the system.
 - **Random:** Default is **Random**. Login code will be randomly generated.
 - **Use the following code:** Enter a 4-digit code. This code will be used to log in to the system.

Click the **Apply** button to save and apply changes. The projector must be restarted for the changes to take effect.

Change Passwords

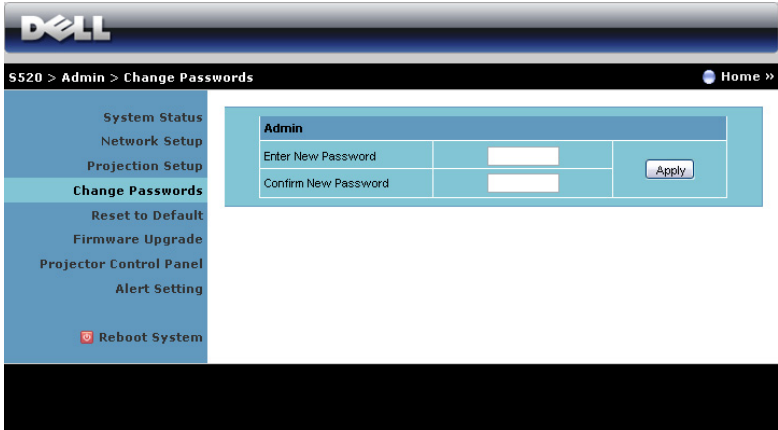

The screenshot shows the Dell S520 Admin interface. At the top, there is a Dell logo and a navigation bar with the text "S520 > Admin > Change Passwords" and a "Home" link. A left-hand menu lists various system settings, with "Change Passwords" highlighted. The main content area is titled "Admin" and contains two input fields: "Enter New Password" and "Confirm New Password". An "Apply" button is located to the right of the second field.

Admin	
Enter New Password	<input type="text"/>
Confirm New Password	<input type="text"/>
<input type="button" value="Apply"/>	

This page allows you to change the administrator password.

- **Enter New Password:** Enter the new password.
- **Confirm New Password:** Enter the password again and click **Apply**.



NOTE: Contact Dell if you forget your administrator password.

Reset to Default

The screenshot shows the Dell projector's web interface. At the top, there is a dark blue header with the 'DELL' logo. Below the header, a breadcrumb trail reads '5520 > Admin > Reset to Default'. On the right side of this bar, there is a 'Home' link with a right-pointing arrow. The left sidebar is a vertical menu with the following items: 'System Status', 'Network Setup', 'Projection Setup', 'Change Passwords', 'Reset to Default' (highlighted in light blue), 'Firmware Upgrade', 'Projector Control Panel', 'Alert Setting', and 'Reboot System' (with a red square icon). The main content area is a light blue box with a yellow warning triangle icon on the left. The text inside the box reads: 'Reset to Default' followed by 'This will restore the Wireless/Network to factory default settings.' At the bottom of this box is a button labeled 'Apply'.

Click the **Apply** button to restore the wireless/network setup to its factory default settings.

Firmware Upgrade

Use the Firmware Upgrade page to update your projector's wireless firmware.

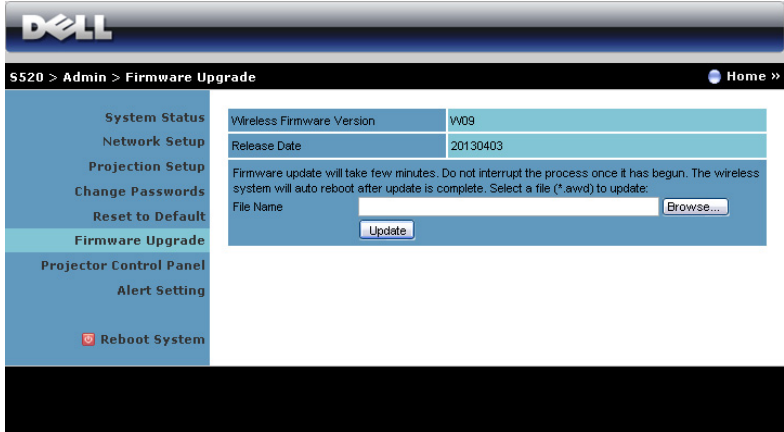

 **NOTE:** Please disable and enable wireless/network using the OSD to restart the network card for the projector after firmware upgrade is successful.

To start firmware update, follow these steps:

- 1 You can download the firmware files from **dell.com/support**.
- 2 Press **Browse** to select the file to update.
- 3 Click the **Update** button to start. Wait while the system updates the firmware in your device.

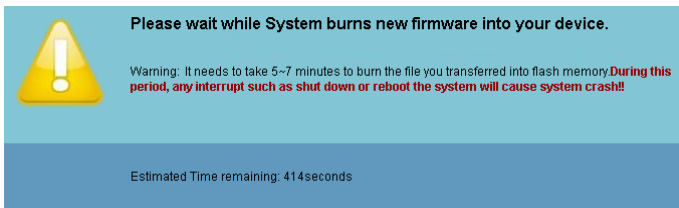

 **CAUTION:** Do not interrupt the update process as this may cause the system to crash!

- 4 Click **OK** when the update is complete.

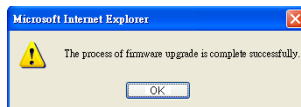

Projector Control Panel

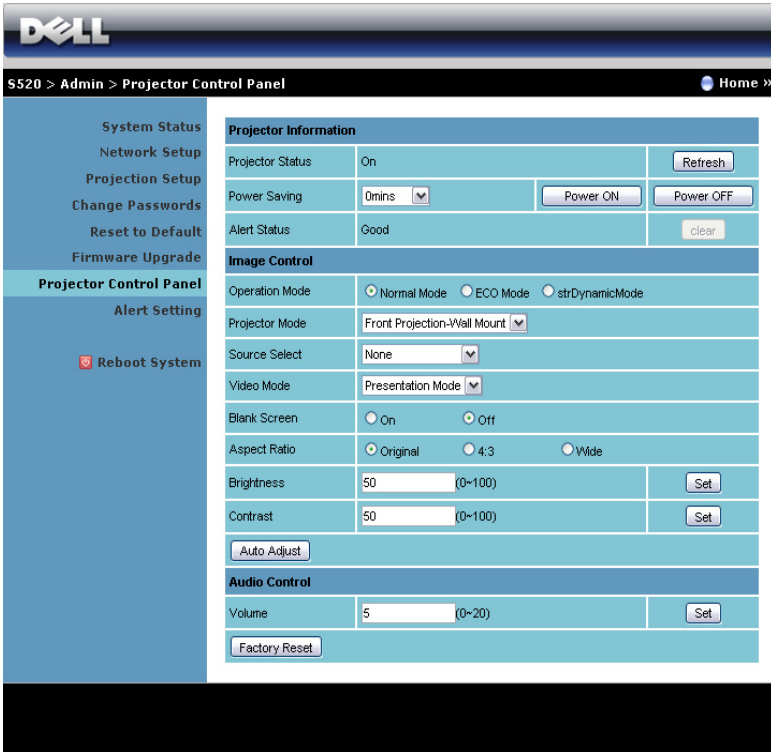

Projector Information

- **Projector Status:** There are five states: Lamp On, Standby, Power Saving, Cooling, and Warming up. Click **Refresh** to refresh the status and control settings.
- **Power Saving:** Power Saving can be set to Off, 30, 60, 90, or 120 minutes. For more information, see "Power Saving" on page 51.
- **Alert Status:** There are three alert states: Lamp warning, Low lamp life, and Temperature warning. Your projector might lock up in the protection mode if any of the alerts are activated. To exit the protection mode, click **Clear** to clear the Alert Status before you power on your projector.

Image Control

- **Projector Mode:** Allows you to select the projector mode, depending on how the projector is mounted. There are two projection modes: Front Projection-Wall Mount and Rear Projection-Wall Mount.
- **Source Select:** The Source Select menu allows you to select your projector's input source. You can select VGA-A, VGA-B, S-Video, Composite Video, HDMI, Wireless Display, USB Display, USB Viewer, Intel® WiDi, or Internal Memory.
- **Video Mode:** Select a mode to optimize the display image based on how the projector is being used:
 - **Presentation:** Best for presentation slides.
 - **Bright:** Maximum brightness and contrast.
 - **Movie:** For viewing movies and photos.
 - **sRGB:** Provides a more accurate color representation.
 - **Custom:** User-preferred settings.
- **Blank Screen:** You can select On or Off.
- **Aspect Ratio:** Allows you to select the aspect ratio to adjust how the image appears.
- **Brightness:** Select value to adjust the brightness of the image.
- **Contrast:** Select value to adjust the display contrast.

Click the **Auto Adjust** button to adjust the settings automatically.

Audio Control

- **Volume:** Select the value (0~20) for audio volume.

Click the **Factory Reset** button to restore the factory default settings.

Alert Setting

System Status
Network Setup
Projection Setup
Change Passwords
Reset to Default
Firmware Upgrade
Projector Control Panel

Alert Setting

Reboot System

E-mail Alert

Enable Disable

To:

Cc:

From:

Subject:

SMTP Setting

Out going SMTP Server:

Username:

Password:

Alert Condition

Lamp warning

Low lamp life

Temperature warning

E-mail Alert

- E-mail Alert: You can set whether to be notified by email (Enable) or not (Disable).
- To/Cc/From: You can enter email address of sender (From) and recipients (To/Cc) to receive notification when an abnormality or warning occurs.
- Subject: You can enter the subject line of the email.

Click the **E-mail Alert Test** button to test the e-mail alert settings.

SMTP Setting

- **Out going SMTP server, User name, and Password** should be provided by your network administrator or MIS.

Alert Condition

- You can select the abnormalities or warnings to be notified by email. When any of the alert conditions occur, an email will be sent to the recipients (To/Cc).

Click the **Save** button to the save settings.



NOTE: E-mail alert is designed to work with a standard SMTP server using the default 25 port. It does not support encryption and authentication (SSL or TLS).

Reboot System

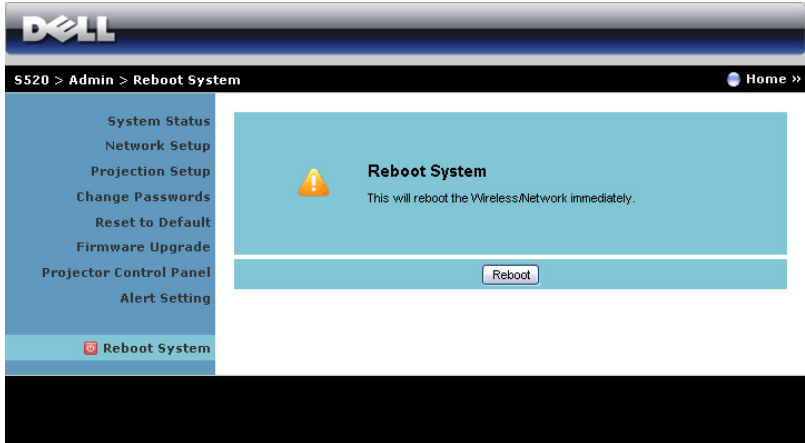

Click **Reboot** to reboot the system.

Crestron



For Crestron function.

FAQS:

I would like to remotely access the projector via the Internet. What is the best setting for the browser?

To have the best setting for the browser, please follow the below steps:

- 1 Open **Control Panel → Internet Options → General tab → Temporary Internet Files → Settings → Select Every visit to the pages.**
 - 2 Some firewall or anti-virus may block the HTTP application. If possible, turn off the firewall or anti-virus.
-

I would like to remotely access the projector via Internet. What socket port number should I open for it in the firewall?

The following are the TCP/IP socket ports which the projector uses.

UDP/TCP	Port Number	Description
TCP	80	Web configuration (HTTP)
UDP/TCP	25	SMTP: used for email routing between mail servers
UDP/TCP	161	SNMP: Simple Network Management Protocol
UDP	9131	AMX: used for AMX discovery

Why am I unable to access the projector via the Internet?

- 1 Check whether your computer/laptop is connected to the Internet.
- 2 Check with your MIS or network administrator whether your computer/laptop is in the same subnet.

Why am I unable to access the SMTP server?

- 1** Check with your MIS or network administrator whether the SMTP server function is open for the projector and the IP assigned to the projector is allowed to access the SMTP server. The projector's SMTP socket port number is 25, this cannot be changed.
- 2** Check if the outgoing SMTP server, user name, and password are set correctly.
- 3** Some SMTP servers will check whether the mail address of "From" correlates with the "User name" and "Password". For example, you use test@dell.com as the mail address in "From". You should also use test@dell.com account information for the User name and the password to log in the SMTP server.

Why am I unable to receive the test alert email even though the projector already indicates the test mail is already sent?

It could be because the SMTP server recognized the alert mail as a spam mail or because of the SMTP server restriction. Check with your MIS or network administrator for the SMTP server's setting.

Firewall Configuration and FAQ

Q: Why can't I access the Web Management Page?

A: Your computer's firewall configuration may prevent you from accessing the Web Management Web Page. Please refer to the following configuration settings:

Firewall Protection	Configuration
McAfee Security Center	<ol style="list-style-type: none">1 Launch McAfee Security Center (Start > All Programs > McAfee > McAfee Security Center).2 On the personal firewall plus tab, click View the Internet Applications List.3 Find and select Dell S520 Projector from the list.4 Right-click on its Permissions column.5 Select Allow Full Access from the pop-up menu.
Norton AntiVirus	<ol style="list-style-type: none">1 Open Norton AntiVirus (Start > All Programs > Norton AntiVirus > Norton AntiVirus).2 Click Options menu, then select Norton AntiVirus.3 On the Status page, select Internet Worm Protection.4 Find and select Dell S520 Projector from the list of programs.5 Right-click on its Internet Access column.6 Select Permit All from the pop-up menu.7 Click OK.
Sygate Personal Firewall	<ol style="list-style-type: none">1 Open Sygate Personal Firewall (Start > All Programs > Sygate > Sygate Personal Firewall).2 From the Running Applications list, find and right-click on Dell S520 Projector.3 Select Allow from the pop-up menu.

Firewall Protection	Configuration
Windows Firewall	<ol style="list-style-type: none"> 1 Open Windows Firewall (Start > All Programs > Control Panel). Double-click on Windows Firewall. 2 On the General tab, uncheck Don't allow exceptions. 3 On the Exceptions tab, click the Add Program... button. 4 Find and select Dell S520 Projector from the list of programs, then click OK. 5 Click OK to confirm exceptions settings.
Zone Alarm	<ol style="list-style-type: none"> 1 Open Zone Alarm Firewall (Start > All Programs > Zone Labs > Zone Labs Center). 2 On the Program Control page, find and select Dell S520 Projector from the list. 3 Right-click on its Access-Trusted column. 4 Select Allow from the pop-up menu. 5 Right-click and select Allow for the Access-Internet, Server-Trusted, and Server-Internet columns.

Make Application Token

The Application Token lets you perform Plug and Show using a USB token.

- 1 From the application software, click  > **USB Dongle**
- 2 The following screen appears. Click **Next**.



- 3 Plug a flash drive into any of the USB ports on your computer. Select the drive from the list, then click **Next**.

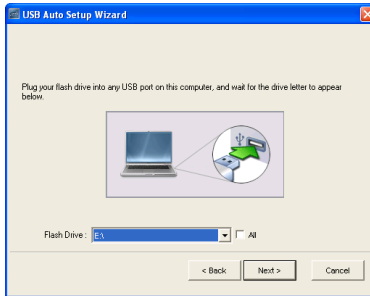

- 4 Click **Finish** to close the wizard.

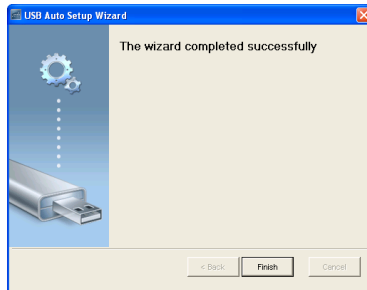

4

Troubleshooting Your Projector



If you experience problems with your projector, see the following troubleshooting tips. If the problem persists, contact Dell (see Contacting Dell on page 122).



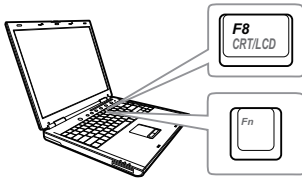

Problem

No image appears on the screen



Possible Solution

- Ensure that you have chosen the correct input source on the INPUT SOURCE menu.
 - Ensure the external graphics port is enabled. If you are using a Dell laptop computer, press   (Fn+F8). For other computers, see your respective documentation. If images are not displayed properly, please upgrade the video driver of your computer. For Dell computers, see support.dell.com.
 - Ensure that all the cables are securely connected. See "Connecting Your Projector" on page 9.
 - Ensure that the pins of the connectors are not bent or broken.
 - Ensure that the lamp is securely installed (see "Changing the Lamp" on page 114).
 - Use Test Pattern in the Projector Settings of the Advanced Settings menu. Ensure that the colors of the test pattern are correct.
-

Problem (continued)	Possible Solution (continued)
Partial, scrolling, or incorrectly displayed image	<ol style="list-style-type: none"> 1 Press the Auto Adjust button on the remote control. 2 If you are using a Dell laptop computer, set the resolution of the computer to WXGA (1280 x 800): <ol style="list-style-type: none"> a Right-click the unused portion of your Microsoft® Windows® desktop, click Properties, and then select Settings tab. b Verify that the setting is 1280 x 800 pixels for the external monitor port. c Press   (Fn+F8).
	<p>If you experience difficulty in changing resolutions, or if your monitor freezes, restart all the equipment and the projector.</p> <p>If you are not using a Dell laptop computer, see your documentation. If images are not displayed properly, please upgrade the video driver of your computer. For a Dell computer, see support.dell.com.</p>
The screen does not display your presentation	If you are using a portable computer, press   (Fn+F8).
Image is unstable or flickering	Adjust the tracking in the OSD Display Settings of the Advanced Settings menu (in PC Mode only).
Image has vertical flickering bar	Adjust the frequency in the OSD Display Settings of the Advanced Settings menu (in PC Mode only).

Problem (continued)	Possible Solution (continued)
Image color is incorrect	<ul style="list-style-type: none"> • If the display receives the wrong signal output from the graphics card, please set the signal type to RGB in the OSD Image Settings of the Advanced Settings tab. • Use Test Pattern in the Projector Settings of the Advanced Settings menu. Ensure that the colors of the test pattern are correct.
Image is out of focus	<ol style="list-style-type: none"> 1 Adjust the focus ring on the projector lens. 2 Ensure that the projection screen is within the required distance from the projector 1.96 ft [0.597 m] to 2.4 ft [0.731 m].
The image is stretched when displaying a 16:9 DVD	<p>The projector automatically detects the input signal format. It will maintain the aspect ratio of the projected image according to input signal format with an Original setting.</p> <p>If the image is still stretched, adjust the aspect ratio in the Display Settings of the Advanced Settings menu in the OSD.</p>
Image is reversed	Select Projector Settings of the Advanced Settings from the OSD and adjust the projector mode.
Lamp is burned out or makes a popping sound	When the lamp reaches its end of life, it may burn out and may make a loud popping sound. If this occurs, the projector does not turn back on. To replace the lamp, see "Changing the Lamp" on page 114.
LAMP light is solid amber	If the LAMP light is solid amber, replace the lamp.

Problem (continued)	Possible Solution (continued)
LAMP light is blinking amber	<p>If the LAMP light is blinking amber, the lamp module connection may be disrupted. Please check the lamp module and ensure that it is properly installed.</p> <p>If the LAMP lights and the Power light are blinking amber, the lamp driver has failed and the projector will automatically shut down.</p> <p>If the LAMP and TEMP lights are blinking amber and the Power light is solid blue, the color wheel has failed and the projector will automatically shut down.</p> <p>To clear the protection mode, press and hold the POWER button for 10 seconds.</p>
TEMP light is solid amber	The projector has overheated. The display automatically shuts down. Turn the display on again after the projector cools down. If the problem persists, contact Dell.
TEMP light is blinking amber	If the projector fan fails, the projector will automatically shut down. Try to clear the projector mode by pressing and holding the Power button for 10 seconds. Please wait for about 5 minutes and try to power up again. If the problem persists, contact Dell.
The OSD does not appear on the screen	Try to press the Menu button on the panel for 15 seconds to unlock the OSD. Check the Menu Lock on page 48.
The remote control is not operating smoothly or works only within a limited range	The battery may be low. If so, replace with two new AAA batteries.

Problem (continued)

DoUSB not displaying

Possible Solution (continued)

- Windows

Display over USB Should run automatically. To manually run USB display, go to My Computer and run "USB_Display.exe".

- MAC

a Go to CDROM: USB_DISPLAY and run "MAC_USB_Display.pkg".

b Follow the on-screen instruction to complete installed.

c Reboot system, and then re-connect USB cable to the computer and the projector.



NOTE: You may require administrator level access to install the driver. Contact your network administrator for support.

Guiding Signals

Projector Status	Description	Control Buttons		Indicator	
		Power	TEMP (Amber)	LAMP (Amber)	
Standby mode	Projector in Standby mode. Ready to power on.	White Flashing	OFF	OFF	OFF
Warming up mode	Projector takes some time to warm up and power on.	White	OFF	OFF	OFF
Lamp on	Projector in Normal mode, ready to display an image.  Note: The OSD menu is not accessed.	White	OFF	OFF	OFF
Cooling mode	Projector is cooling to shutdown.	White	OFF	OFF	OFF
Projector overheated	Air vents might be blocked or ambient temperature may be above 35 °C. The projector automatically shuts down. Ensure that the air vents are not blocked and that the ambient temperature is within operational range. If the problem persists, contact Dell.	OFF	AMBER	OFF	OFF
Lamp driver overheated	The lamp driver is overheated. The air vents may be blocked. The projector automatically shuts down. Turn the display on again after the projector cools down. If the problem persists, contact Dell.	AMBER	AMBER	OFF	OFF
Fan breakdown	One of the fans has failed. The projector automatically shuts down. If the problem persists, contact Dell.	OFF	AMBER Flashing	OFF	OFF
Lamp driver breakdown	The lamp driver has failed. The projector automatically shuts down. Unplug the power cord after three minutes and then turn the display on again. If this problem persists, contact Dell.	AMBER Flashing	OFF	AMBER Flashing	AMBER Flashing
Color Wheel breakdown	Color wheel cannot start. The projector has failed and the projector automatically shuts down. Unplug the power cord after three minutes and then turn on the projector. If this problem persists, contact Dell.	White	AMBER Flashing	AMBER Flashing	AMBER Flashing
Lamp failure	Lamp is defective. Replace the lamp.	OFF	OFF	AMBER	AMBER
Fault - DC supply (+12V)	Power supply has been interrupted. The projector automatically shuts down. Unplug the power cord after three minutes and then turn on the projector. If this problem persists, contact Dell.	AMBER Flashing	AMBER	AMBER	AMBER
Lamp module connection failed	Lamp module connection may be disrupted. Check the lamp module and ensure that it is properly installed. If the problem persists, contact Dell.	OFF	OFF	AMBER Flashing	AMBER Flashing

Laser Curtain LED Guiding Signals

Status	Description	LED (White)	LED (Red)
InterLock switch fail	Laser curtain isn't installed properly, yet Interlock Swtich isn't located correctly. Please check the installation position of laser curtain. If the warning signal keeps operating, please contact Service Center.	Flash (0.5s)	OFF
Normal status	Laser Curtain is functioning correctly.	ON	OFF
Laser Diode doesn't work	Laser Module is not operation, please contact Service Center.	OFF	ON

Changing the Lamp

CAUTION: Before you begin any of the procedures in this section, follow the Safety Instructions as described on page 8.

Replace the lamp when the message "**Lamp is approaching the end of its useful life in the operation. Replacement suggested!**" appears on the screen. If this problem persists after replacing the lamp, contact Dell. For more information, see "Contacting Dell" on page 122.

CAUTION: Use an original lamp to ensure safe and optimal working condition of your projector.

CAUTION: The lamp becomes very hot when in use. Do not attempt to replace the lamp until the projector has been allowed to cool down for at least 30 minutes.

CAUTION: Do not touch the bulb or the lamp glass at any time. Projector lamps are very fragile and may shatter if touched. The shattered glass pieces are sharp and can cause injury.

CAUTION: If the lamp shatters, remove all broken pieces from the projector and dispose or recycle according to state, local, or federal law. For more information see www.dell.com/hg.

- 1 Turn off the projector and disconnect the power cord.
- 2 Let the projector cool for at least 30 minutes.
- 3 Loosen the two screws that secure the lamp cover, and remove the cover.
- 4 Loosen the two screws that secure the lamp.
- 5 Pull the lamp up by its metal handle.

NOTE: Dell may require lamps replaced under warranty to be returned to Dell. Otherwise, contact your local waste disposal agency for the address of the nearest deposit site.

- 6 Replace with the new lamp.
- 7 Tighten the two screws that secure the lamp.
- 8 Replace the lamp cover and tighten the two screws.

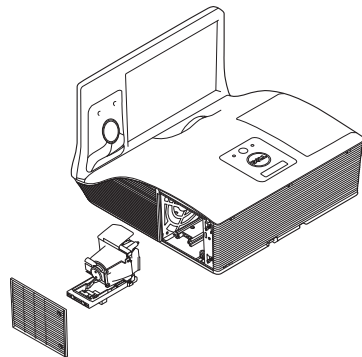

9 Reset the lamp usage time by selecting "Yes" for **Lamp Reset** in the OSD **Power Settings** of the **Advanced Settings** menu (see Power Settings of the Advanced Setting menu on page 50). When a new lamp module has been changed, the projector will automatically detect and reset the lamp hours.



CAUTION: Lamp Disposal (for the US only)

 **LAMP(S) INSIDE THIS PRODUCT CONTAIN MERCURY AND MUST BE RECYCLED OR DISPOSED OF ACCORDING TO LOCAL, STATE, OR FEDERAL LAWS. FOR MORE INFORMATION, GO TO WWW.DELL.COM/HG OR CONTACT THE ELECTRONIC INDUSTRIES ALLIANCE AT WWW.EIAE.ORG. FOR LAMP-SPECIFIC DISPOSAL INFORMATION, CHECK WWW.LAMPRECYCLE.ORG.**

5

Specifications

Light Valve	0.65" WXGA-800 S450 DMD, DarkChip3™
Brightness	3100 ANSI Lumens (Max.)
Contrast Ratio	Native: 2200:1 Typical High Contrast Ratio Mode: 8000:1 Typical
Uniformity	85% Typical (Japan Standard - JBMA)
Number of Pixels	1280 x 800 (WXGA)
Aspect Ratio	16:10
Internal Flash	2 GB Memory (Max.)
Displayable Color	1.07 billion colors
Color Wheel Speed	2 X 1 X for 3D Display
Projection Lens	F-Stop: F/ 2.6 Effective Focal length=654 mm \pm 10 mm @ 87.2 screen size 1X manual Zoom Lens, Fix Throw ratio =0.35 wide and tele Offset Ratio: 125% \pm 5%
Projection Screen Size	70 ~ 100 inches (diagonal)
Projection Distance	1.7 ~ 2.49 ft (0.517 ~ 0.759 m \pm 0.01 m)
Video Compatibility	Composite Video/S-Video: NTSC: M (3.58 MHz), 4.43 MHz PAL: B, D, G, H, I, M, N, 60 SECAM: B, D, G, K, K1, L Component Video input via VGA: 1080i, 720p, 576i/p, 480i/p HDMI input: 1080p, 720p, 576i/p, 480i/p
Power Supply	Universal AC 100-240 V 50-60 Hz with PFC input

Power Consumption	Normal mode: 345 W \pm 10% @ 110 Vac (Network On) Eco mode: 285 W \pm 10% @ 110 Vac (Network On) Standby mode: < 0.5 W
Audio	2 speaker x 10 watt RMS
Noise Level	Normal mode: 36 dB(A) Eco mode: 32 dB(A)
Projector Weight	18.74 lbs (8.5 kg)
Dimensions (W x H x D)	14.1 x 9.1 x 14.4 inches (357 x 231 x 367 mm)

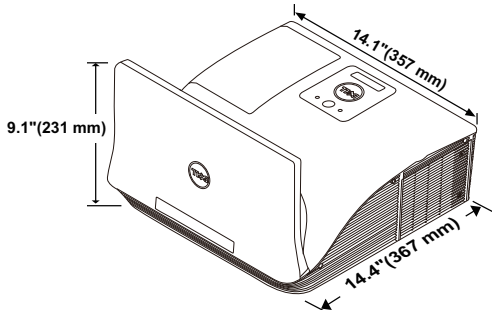

Environmental	Operating temperature: 5 °C - 40 °C (41 °F-104 °F) Humidity: 80% maximum Storage temperature: 0 °C to 60 °C (32 °F to 140 °F) Humidity: 90% maximum Shipping temperature: -20 °C to 60 °C (-4 °F to 140 °F) Humidity: 90% maximum
---------------	--

I/O Connectors	Power: One AC power socket (3-pin - C14 inlet) VGA input: Two 15-pin D-sub connectors (Blue), VGA-A and VGA-B, for analog RGB/Component input signals. VGA output: One 15-pin D-sub connector (Black) for VGA-A loop through.
----------------	---

S-Video input: One standard 4-pin min-DIN S-Video connector for Y/C signal.

Composite Video input: One Yellow RCA jack for CVBS signal.

HDMI input: One HDMI connector for supporting HDMI 1.4a. HDCP compliant.

Analog Audio input: Two 3.5 mm stereo mini phone jack (Blue) and two pair of RCA connector (Red/White).

Variable audio output: One 3.5 mm stereo mini phone jack (Green).

USB (type B) port: One mini USB slave for remote support, firmware upgrade, and laser curtain touch HID.

RS232 port: One 9-pin D-sub for RS232 communication.

USB (type A) port: One USB connector for multimedia playback (Video/Music/Photo/Office Viewer) and USB memory storage access (USB flash drive/internal memory).

USB (type B) port: One USB connector for supporting USB display.

RJ45 port: One RJ45 connector for control of projector through network and LAN display.

Microphone

One 3.5 mm stereo mini phone jack (Pink).

Laser Curtain

One 12 V DC/200 mA max. output for driving laser curtain.

Wireless

Wireless Standard: IEEE 802.11 a/b/g/n (2T2R)

OS environment: Windows 8/7/Vista/XP/2000,
MAC OS X

Support: Presentation slides and projector
control.

Allow connection up to 30 users at the same
time.

4-to-1 split screen. Allows four presentation
slides to be projected on screen.

Conference Control mode.

Supports Audio Projection (driver installation
may be required. Download from
dell.com/support).

Supports MobiShow and WiFi-Doc projection.

Lamp

OSRAM 280 W user-replaceable lamp

Lamp life

Normal mode: 3000 hours

Eco mode: 4000 hours

Dynamic eco cycle mode: 4500 hours



NOTE: The lamp life rating for any projector is a measure of brightness degradation only, and is not a specification for the time it takes a lamp to fail and cease light output. Lamp life is defined as the time it takes for more than 50 percent of a lamp sample population to have brightness decrease by approximately 50 percent of the rated lumens for the specified lamp. The lamp life rating is not guaranteed in any way. The actual operating life span of a projector lamp will vary according to operating conditions and usage patterns. Usage of a projector in stressful conditions which may include dusty environments, under high temperatures, many hours per day, and abrupt powering-off will most likely result in a lamp's shortened operating life span or possible lamp failure.

RS232 Pin Assignment

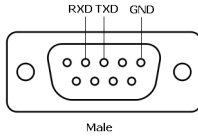

RS232 Protocol

- Communication Settings

Connection settings	Value
Baud Rate	19,200
Data Bits	8
Parity	None
Stop Bits	1

- Command types
To pop up the OSD menu and adjust the settings.
- Control command Syntax (From PC to Projector)
[H][AC][SoP][CRC][ID][SoM][COMMAND]
- Example: Power ON Command (Send low byte firstly)
--> 0xBE, 0xEF, 0x10, 0x05, 0x00, 0xC6, 0xFF, 0x11, 0x11, 0x01, 0x00, 0x01
- Control Commands List
To view the latest RS232 code, go to the Dell Support site at support.dell.com.
To view the latest SNMP commands and list, go to the Dell Support site at support.dell.com.

Compatibility Modes (Analog/Digital)

Resolution	Refresh Rate (Hz)	Hsync Frequency (KHz)	Pixel Clock (MHz)
640 x 350	70.087	31.469	25.175
640 x 480	59.940	31.469	25.175
720 x 480 p60	59.940	31.469	27.000
720 x 576 p50	50.000	31.250	27.000
720 x 400	70.087	31.469	28.322
640 x 480	75.000	37.500	31.500
640 x 480	85.008	43.269	36.000
800 x 600	60.317	37.879	40.000
800 x 600	75.000	46.875	49.500
800 x 600	85.061	53.674	56.250
1024 x 768	60.004	48.363	65.000
1280 x 720 p50	50.000	37.500	74.250
1280 x 720 p60	60.000	45.000	74.250
1920 x 1080 i50	50.000	28.125	74.250
1920 x 1080 i60	60.000	33.750	74.250
1280 x 720	59.855	44.772	74.500
1024 x 768	75.029	60.023	78.750
1280 x 800	59.810	49.702	83.500
1366 x 768	59.790	47.712	85.500
1360 x 768	60.015	47.712	85.500
1024 x 768	84.997	68.677	94.500
1440 x 900	59.887	55.935	106.500
1280 x 1024	60.020	63.981	108.000
1400 x 1050	59.978	65.317	121.750
1280 x 800	84.880	71.554	122.500
1280 x 1024	75.025	79.976	135.000
1440 x 900	74.984	70.635	136.750
1680 x 1050	59.954	65.290	146.250
1280 x 960	85.002	85.938	148.500
1920 x 1080	60.000	67.500	148.500
1024 x 768	119.989	97.551	115.500

6

Contacting Dell

For customers in the United States, call 800-WWW-DELL (800-999-3355).



NOTE: If you do not have an active Internet connection, you can find contact information on your purchase invoice, packing slip, bill, or Dell product catalog.

Dell provides several online and telephone-based support and service options. Availability varies by country and product, and some services may not be available in your area. To contact Dell for sales, technical support, or customer service issues:

- 1 Visit go to www.dell.com/contactDell.
- 2 Select your region on the interactive map.
- 3 Select a Segment for Contact.
- 4 Select the appropriate service or support link based on your need.

Contacting eInstruction

eInstruction provides phone based and online technical support options. Availability varies by country, but an e-mail to techsupport@einstruction.com can be directed appropriately for users in any country.

USA eInstruction Software Technical Support

Phone: 480-443-2214 or 800-856-0732

Email: Techsupport@einstruction.com

International eInstruction Software Technical Support, EMEA

Phone: +33 1 58 31 1065

Email: EU.Support@einstruction.com

Web-based Technical Support is available at:

www.einstruction.com (in US)

www.einstruction.de (in Germany)

www.einstruction.fr (in France)

www.einstruction.it (in Italy)

www.einstruction.es (in Spain)

Contacting Crestron

Crestron provides phone based and online technical support options. Availability varies by country, but an e-mail to getroomview@crestron.com can be directed appropriately for users in any country.

Technical Support

In the US and Canada

Phone: 877-516-5394

Email: roomviewsupport@crestron.com

Outside the US and Canada

Phone: +1 201-367-1037

Email: roomviewsupport@crestron.com

7

Appendix: Glossary

ANSI Lumens — A standard for measuring the brightness. It is calculated by dividing a square meter image into nine equal rectangles, measuring the lux (or brightness) reading at the center of each rectangle, and averaging these nine points.

Aspect Ratio — The most popular aspect ratio is 4:3 (4 by 3). Early television and computer video formats are in a 4:3 aspect ratio, which means that the width of the image is 4/3 times the height.

Brightness — The amount of light emitted from a display or projection display or projection device. The brightness of projector is measured by ANSI lumens.

Color Temperature — The color appearance of white light. Low color temperature implies warmer (more yellow/red) light while high color temperature implies a colder (more blue) light. The standard unit for color temperature is Kelvin (K).

Component Video — A method of delivering quality video in a format that consists of the luminance signal and two separate chrominance signals and are defined as Y'Pb'Pr' for analog component and Y'Cb'Cr' for digital component. Component video is available on DVD players.

Composite Video — A video signal that combines the luma (brightness), chroma (color), burst (color reference), and sync (horizontal and vertical synchronizing signals) into a signal waveform carried on a single wire pair. There are three kinds of formats, namely, NTSC, PAL, and SECAM.

Compressed Resolution — If the input images are of higher resolution than the native resolution of the projector, the resulting image will be scaled to fit the native resolution of the projector. The nature of compression in a digital device means that some image content is lost.

Contrast Ratio — Range of light and dark values in a picture, or the ratio between their maximum and minimum values. There are two methods used by the projection industry to measure the ratio:

- 1 *Full On/Off* — measures the ratio of the light output of an all white image (full on) and the light output of an all black (full off) image.
- 2 *ANSI* — measures a pattern of 16 alternating black and white rectangles. The average light output from the white rectangles is divided by the

average light output of the black rectangles to determine the *ANSI* contrast ratio.

Full On/Off contrast is always a larger number than *ANSI* contrast for the same projector.

dB — decibel — A unit used to express relative difference in power or intensity, usually between two acoustic or electric signals, equal to ten times the common logarithm of the ratio of the two levels.

Diagonal Screen — A method of measuring the size of a screen or a projected image. It measures from one corner to the opposite corner. A 9 FT high, 12 FT wide, screen has a diagonal of 15 FT. This document assumes that the diagonal dimensions are for the traditional 4:3 ratio of a computer image as per the example above.

DHCP — Dynamic Host Configuration Protocol — A network protocol that enables a server to automatically assign a TCP/IP address to a device.

DLP® — Digital Light Processing™ — Reflective display technology developed by Texas Instruments, using small manipulated mirrors. Light passing through a color filter is sent to the DLP mirrors which arrange the RGB colors into a picture projected onto screen, also known as DMD.

DMD — Digital Micro-Mirror Device — Each DMD consists of thousands of tilting, microscopic aluminum alloy mirrors mounted on a hidden yoke.

DNS — Domain Name System — An Internet service that translates domain names into IP addresses.

Focal Length — The distance from the surface of a lens to its focal point.

Frequency — It is the rate of repetition in cycles per seconds of electrical signals. Measured in Hz (Hertz).

HDCP — High-Bandwidth Digital-Content Protection — A specification developed by Intel™ Corporation to protect digital entertainment across digital interface, such as DVI, HDMI.

HDMI — High-Definition Multimedia Interface — HDMI carries both uncompressed high definition video along with digital audio and device control data in a single connector.

Hz (Hertz) — Unit of frequency.

IEEE802.11 — A set of standards for wireless local area network (WLAN) communication. 802.11b/g/n uses the 2.4 GHz band.

Keystone Correction — Device that will correct an image of the distortion (usually a wide-top narrow-bottom effect) of a projected image caused by improper projector to screen angle.

Maximum Distance — The distance from a screen the projector can be to cast an image that is usable (bright enough) in a fully darkened room.

Maximum Image Size — The largest image a projector can throw in a darkened room. This is usually limited by focal range of the optics.

Minimum Distance — The closest position that a projector can focus an image onto a screen.

NTSC — National Television Standards Committee. North American standard for video and broadcasting, with a video format of 525 lines at 30 frames per second.

PAL — Phase Alternating Line. A European broadcast standard for video and broadcasting, with a video format of 625 lines at 25 frames per second.

Reverse Image — Feature that allows you to flip the image horizontally. When used in a normal forward projection environment text, graphics, etc. are backwards. Reverse image is used for rear projection.

RGB — Red, Green, Blue — typically used to describe a monitor that requires separate signals for each of the three colors.

S-Video — A video transmission standard that uses a 4-pin mini-DIN connector to send video information on two signal wires called luminance (brightness, Y) and chrominance (color, C). S-Video is also referred to as Y/C.

SECAM — A French and international broadcast standard for video and broadcasting, closely related to PAL but with a different method of sending color information.

SSID — Service Set Identifiers — A name used to identify the particular wireless LAN to which a user wants to connect.

SVGA — Super Video Graphics Array — 800 x 600 pixels count.

SXGA — Super Extended Graphics Array, — 1280 x 1024 pixels count.

UXGA — Ultra Extended Graphics Array — 1600 x 1200 pixels count.

VGA — Video Graphics Array — 640 x 480 pixels count.

WEP — Wired Equivalent Privacy — This is a method for encrypting communication data. The encryption key is created and notified only to the communicating user, so the communication data cannot be decrypted by a third party.

XGA — Extended Video Graphics Array — 1024 x 768 pixels count.

WXGA — Wide Extended Graphics Array — 1280 x 800 pixels count.

Index

A

- Adjusting the Projector Focus 26
 - Focus ring 26

C

- Changing the Lamp 114
- Connecting the Projector
 - Composite Video cable 18
 - Connecting a Computer with a RS232 cable 13, 14
 - Connecting with a Component Cable 19
 - Connecting with a Composite Cable 18
 - Connecting with an HDMI Cable 20
 - Connecting with an S-video Cable 17
 - DC to DC cable 23
 - HDMI cable 20, 21, 22
 - Laser curtain 23
 - Power cord 11, 12, 13, 14, 17, 18, 19, 20, 21, 22, 23
 - RS232 cable 13
 - S-Video cable 17
 - To Computer 11
 - USB to USB cable 11
 - USB-A to Mini USB-B cable 23
 - USB-A to USB-B cable 14
 - VGA to VGA cable 11, 12, 23
 - VGA to YPbPr cable 19
 - Whiteboard 23
- Connection Ports
 - Audio-B left-channel input connector 9
 - Audio-B right-channel input connector 9
 - Composite Video connector 9
 - HDMI connector 9
 - Mini USB for remote mouse, Interactive function and Firmware upgrade. 9
 - RJ45 connector 9
 - RS232 connector 9
 - Security cable slot 9
 - S-Video connector 9
 - USB Type A Viewer connector 9
 - USB Type B Display connector 9
 - VGA-A input (D-sub) connector 9
 - VGA-A output (monitor loop-through) 9
 - VGA-B input (D-sub) connector 9
- Contact Dell 5, 110, 114

D

Dell

contacting 122, 125

M

Main Unit 7

5W speaker 7

Control panel 7

Focus tab 7

IR receivers 7

Lens 7

Lens cap 7

O

On-Screen Display 34

ADVANCED SETTINGS 38

AUDIO INPUT 38

AUTO ADJUST 36

BRIGHTNESS/CONTRAST 36

HELP 53

INPUT SOURCE 34

INPUT SOURCE MULTIPLE
DISPLAY 35

LANGUAGE 52

Main Menu 34

VIDEO MODE 37

VOLUME 37

P

phone numbers 122

Powering On/Off the Projector

Powering Off the Projector 25

Powering On the Projector 25

R

Remote Control 29

S

Specifications

Audio 117

Brightness 116

Color Wheel Speed 116

Contrast Ratio 116

Dimensions 117

Displayable Color 116

Environmental 117

I/O Connectors 117

Light Valve 116

Noise Level 117

Number of Pixels 116

Power Consumption 117

Power Supply 116

Projection Distance 116

Projection Lens 116

Projection Screen Size 116

RS232 Protocol 120

Uniformity 116

Video Compatibility 116

Weight 117

support

contacting Dell 122, 125

T

telephone numbers 122

Troubleshooting 107
Contact Dell 107